

# PROGRAMMING MANUAL

---

## AC/DC POWER SOURCE ASR SERIES



## ■ **About a trademark, a registered trademark**

A company name and the brand name mentioned in this instruction manual are the trademark or the registered trademark of each company or group in each country and region.

## ■ **About this instruction manual**

When copying the part or all of contents of this instruction manual, seek the copyright holder.

In addition, the specifications of the product and the contents of this instruction manual are subject to change without notice for improvement. The latest version of the instruction manual is posted on our website. (<https://www.texio.co.jp/>)

For the purpose of considering the environment and reducing waste, we are progressively eliminating the paper or CD manuals attached to our products.

## ■ **About firmware version**

This programming manual is required firmware version 1.36 or higher.

# CONTENTS

<b>1. REMOTE CONTROL .....</b>	<b>1</b>
1-1. Interface Configuration .....	1
1-1-1. Configure Ethernet Connection .....	1
1-1-2. Web Server Remote Control Function Check .....	3
1-1-3. Socket Server Function Check .....	4
1-2. USB Interface .....	8
1-2-1. USB Remote Interface .....	8
1-2-2. USB Remote Control Function Check .....	9
1-3. RS-232C Interface .....	10
1-3-1. RS-232C Remote Interface .....	10
1-3-2. RS-232C Remote Control Function Check .....	11
1-3-3. Using Realterm to Establish a Remote Connection .....	12
1-4. GP-IB Interface .....	15
1-4-1. GPIB Remote Interface .....	15
1-4-2. GPIB Function Check .....	16
<b>2. Command Syntax .....</b>	<b>19</b>
<b>3. Command List .....</b>	<b>22</b>
3-1. Common Commands .....	22
3-1-1. *CLS .....	22
3-1-2. *ESE .....	22
3-1-3. *ESR .....	22
3-1-4. *IDN .....	23
3-1-5. *OPC .....	23
3-1-6. *RCL .....	23
3-1-7. *RST .....	24
3-1-8. *SAV .....	24
3-1-9. *SRE .....	24
3-1-10. *STB .....	25
3-1-11. *WAI .....	25
3-2. Trace/Data Commands .....	26
3-2-1. :DATA TRACe:SEQuence:CLEar .....	26
3-2-2. :DATA TRACe:SEQuence:RECall .....	26
3-2-3. :DATA TRACe:SEQuence:STORe .....	27
3-2-4. :DATA TRACe:SIMulation:CLEar .....	27
3-2-5. :DATA TRACe:SIMulation:RECall .....	28
3-2-6. :DATA TRACe:SIMulation:STORe .....	28
3-2-7. :DATA TRACe:WAVe:CLEar .....	29
3-2-8. :DATA TRACe:WAVe[:DATA] .....	29
3-3. Measure Commands .....	30
3-3-1. :MEASure[:SCALar]:CURRent:CFACTOR .....	30
3-3-2. :MEASure[:SCALar]:CURRent:HIGH .....	30
3-3-3. :MEASure[:SCALar]:CURRent:LOW .....	30
3-3-4. :MEASure[:SCALar]:CURRent:PEAK:CLEar .....	30

3-3-5.	:MEASure[:SCALar]:CURRent:PEAK:HOLD .....	31
3-3-6.	:MEASure[:SCALar]:CURRent[:RMS] .....	31
3-3-7.	:MEASure[:SCALar]:CURRent:AVERAge .....	31
3-3-8.	:MEASure[:SCALar]:CURRent:HARMonic[:RMS] .....	31
3-3-9.	:MEASure[:SCALar]:CURRent:HARMonic:RATio .....	32
3-3-10.	:MEASure[:SCALar]:FREQuency .....	32
3-3-11.	:MEASure[:SCALar]:POWer[:AC]:APParent .....	32
3-3-12.	:MEASure[:SCALar]:POWer[:AC]:PFACtor .....	32
3-3-13.	:MEASure[:SCALar]:POWer[:AC]:REACTive .....	33
3-3-14.	:MEASure[:SCALar]:POWer[:AC][:REAL] .....	33
3-3-15.	:MEASure[:SCALar]:VOLTage[:RMS] .....	33
3-3-16.	:MEASure[:SCALar]:VOLTage:AVERAge .....	33
3-3-17.	:MEASure[:SCALar]:VOLTage:HIGH .....	34
3-3-18.	:MEASure[:SCALar]:VOLTage:LOW .....	34
3-3-19.	:MEASure[:SCALar]:VOLTage:HARMonic[:RMS] .....	34
3-3-20.	:MEASure[:SCALar]:VOLTage:HARMonic:RATio .....	35
3-3-21.	:MEASure:CONFigure:SENSing .....	35
3-3-22.	:MEASure:AVERAge:COUNt .....	36
3-3-23.	:MEASure:UPDate:RATE .....	36
<b>3-4.</b>	<b>Memory Commands .....</b>	<b>37</b>
3-4-1.	:MEMory:RCL .....	37
3-4-2.	:MEMory:SAV .....	37
<b>3-5.</b>	<b>Output Commands .....</b>	<b>38</b>
3-5-1.	:OUTPut[:STATe] .....	38
3-5-2.	:OUTPut:PON .....	38
3-5-3.	:OUTPut:PROTection:CLEar .....	39
3-5-4.	:OUTPut:RELAy .....	39
<b>3-6.</b>	<b>Status Commands .....</b>	<b>40</b>
3-6-1.	:STATus:OPERation:CONDition .....	40
3-6-2.	:STATus:OPERation:ENABle .....	40
3-6-3.	:STATus:OPERation[:EVENT] .....	40
3-6-4.	:STATus:OPERation:NTRansition .....	40
3-6-5.	:STATus:OPERation:PTRansition .....	41
3-6-6.	:STATus:QUEStionable[:EVENT] .....	41
3-6-7.	:STATus:QUEStionable:CONDition .....	41
3-6-8.	:STATus:QUEStionable:ENABle .....	42
3-6-9.	:STATus:QUEStionable:NTRansition .....	42
3-6-10.	:STATus:QUEStionable:PTRansition .....	42
3-6-11.	:STATus:PRESet .....	43
3-6-12.	:STATus:WARning:CONDition .....	44
3-6-13.	:STATus:WARning:ENABle .....	44
3-6-14.	:STATus:WARning[:EVENT] .....	44
3-6-15.	:STATus:WARning:NTRansition .....	45
3-6-16.	:STATus:WARning:PTRansition .....	45
3-6-17.	:STATus:LOCK:CONDition .....	45
3-6-18.	:STATus:LOCK:ENABle .....	46
3-6-19.	:STATus:LOCK[:EVENT] .....	46
3-6-20.	:STATus:LOCK:NTRansition .....	46
3-6-21.	:STATus:LOCK:PTRansition .....	47
<b>3-7.</b>	<b>System Function Commands .....</b>	<b>48</b>
3-7-1.	:SYSTem:ACIN:DETection .....	48

3-7-2.	:SYSTem:ARBITrary:EDIT:BUILtin.....	48
3-7-3.	:SYSTem:ARBITrary:EDIT:SURGe.....	49
3-7-4.	:SYSTem:ARBITrary:EDIT:STAir.....	49
3-7-5.	:SYSTem:ARBITrary:EDIT:CFACTOR2.....	50
3-7-6.	:SYSTem:ARBITrary:EDIT:CFACTOR1.....	50
3-7-7.	:SYSTem:ARBITrary:EDIT:CLIP.....	51
3-7-8.	:SYSTem:ARBITrary:EDIT:STORe.....	52
3-7-9.	:SYSTem:ARBITrary:EDIT:TRlangle.....	53
3-7-10.	:SYSTem:BEEPer:STATe.....	53
3-7-11.	:SYSTem:COMMunicate:GPIB[:SELF]:ADDReSS.....	54
3-7-12.	:SYSTem:COMMunicate:LAN:DHCP.....	54
3-7-13.	:SYSTem:COMMunicate:LAN:DNS.....	55
3-7-14.	:SYSTem:COMMunicate:LAN:GATEWay.....	55
3-7-15.	:SYSTem:COMMunicate:LAN:IPADdress.....	56
3-7-16.	:SYSTem:COMMunicate:LAN:MAC.....	56
3-7-17.	:SYSTem:COMMunicate:LAN:SMASk.....	56
3-7-18.	:SYSTem:COMMunicate:RLSTate.....	57
3-7-19.	:SYSTem:COMMunicate:SERial[:RECeive]:TRANSMit:BAUD.....	57
3-7-20.	:SYSTem:COMMunicate:SERial[:RECeive]:TRANSMit:BITS.....	58
3-7-21.	:SYSTem:COMMunicate:SERial[:RECeive]:TRANSMit:PARity.....	58
3-7-22.	:SYSTem:COMMunicate:SERial[:RECeive]:TRANSMit:SBITs.....	59
3-7-23.	:SYSTem:COMMunicate:TCPip:CONTRol.....	59
3-7-24.	:SYSTem:COMMunicate:USB:FRONT:STATe.....	60
3-7-25.	:SYSTem:COMMunicate:USB:REAR:STATe.....	60
3-7-26.	:SYSTem:CONFigure[:MODE].....	60
3-7-27.	:SYSTem:CONFigure:EXTio[:STATe].....	61
3-7-28.	:SYSTem:CONFigure:TRIGger:OUTPut:SOURce.....	61
3-7-29.	:SYSTem:CONFigure:TRIGger:OUTPut:WIDTh.....	61
3-7-30.	:SYSTem:ERRor.....	62
3-7-31.	:SYSTem:ERRor:ENABle.....	62
3-7-32.	:SYSTem:HOLD:STATe.....	62
3-7-33.	:SYSTem:IPKHold:TIME.....	63
3-7-34.	:SYSTem:KLOCK.....	63
3-7-35.	:SYSTem:REBoot.....	63
3-7-36.	:SYSTem:SCPI:DATA CLEar.....	63
3-7-37.	:SYSTem:SCPI:DATA.....	64
3-7-38.	:SYSTem:SCPI:DATA? Error.....	64
3-7-39.	:SYSTem:SLEW:MODE.....	64
3-7-40.	:SYSTem:VUNit.....	64

## 3-8. Source Commands..... 65

3-8-1.	[:SOURce]:CURRent:LIMit:PEAK:HIGH.....	65
3-8-2.	[:SOURce]:CURRent:LIMit:PEAK:LOW.....	65
3-8-3.	[:SOURce]:CURRent:LIMit:RMS[:AMPLitude].....	66
3-8-4.	[:SOURce]:CURRent:LIMit:PEAK:MODE.....	66
3-8-5.	[:SOURce]:CURRent:LIMit:RMS:MODE.....	67
3-8-6.	[:SOURce]:FREQuency:LIMit:HIGH.....	67
3-8-7.	[:SOURce]:FREQuency:LIMit:LOW.....	68
3-8-8.	[:SOURce]:FREQuency[:IMMEDIATE].....	68
3-8-9.	[:SOURce]:FUNCTion[:SHAPE][:IMMEDIATE].....	69
3-8-10.	[:SOURce]:FUNCTion:THD:FORMAT.....	70
3-8-11.	[:SOURce]:MODE.....	70
3-8-12.	[:SOURce]:PHASe:START:STATe.....	71
3-8-13.	[:SOURce]:PHASe:STOP:STATe.....	71

3-8-14. [:SOURCE]:PHASe:StARt[:IMMediate] .....	72
3-8-15. [:SOURCE]:PHASe:StOP[:IMMediate] .....	72
3-8-16. [:SOURCE]:PHASe:SYNC[:IMMediate] .....	73
3-8-17. [:SOURCE]:REAd .....	73
3-8-18. [:SOURCE]:VOLTAge:RANGe .....	74
3-8-19. [:SOURCE]:VOLTAge:LIMit:RMS .....	74
3-8-20. [:SOURCE]:VOLTAge:LIMit:HIGH .....	75
3-8-21. [:SOURCE]:VOLTAge:LIMit:LOW .....	75
3-8-22. [:SOURCE]:VOLTAge:LIMit:PEAK .....	76
3-8-23. [:SOURCE]:VOLTAge[:LEVel][:IMMediate][:AMPLitude] .....	76
3-8-24. [:SOURCE]:VOLTAge[:LEVel][:IMMediate]:OFFSet .....	77
<b>3-9. Sequence Commands .....</b>	<b>78</b>
3-9-1. [:SOURCE]:SEQuence:CPARAmeter .....	78
3-9-2. [:SOURCE]:SEQuence:CStEp .....	79
3-9-3. [:SOURCE]:SEQuence:SPARAmeter .....	79
3-9-4. [:SOURCE]:SEQuence:StEP .....	80
3-9-5. [:SOURCE]:SEQuence:CONDition .....	81
3-9-6. :TRIGger:SEQuence:SELEcted:EXECute .....	81
<b>3-10. Simulate Commands .....</b>	<b>82</b>
3-10-1. [:SOURCE]:SIMulation:CONDition .....	82
3-10-2. [:SOURCE]:SIMulation:ABNormal:CODE .....	82
3-10-3. [:SOURCE]:SIMulation:ABNormal:FREQuency .....	83
3-10-4. [:SOURCE]:SIMulation:ABNormal:PHASe:StARt:ENABle .....	83
3-10-5. [:SOURCE]:SIMulation:ABNormal:PHASe:StARt[:IMMediate] .....	84
3-10-6. [:SOURCE]:SIMulation:ABNormal:PHASe:StOP:ENABle .....	84
3-10-7. [:SOURCE]:SIMulation:ABNormal:PHASe:StOP[:IMMediate] .....	85
3-10-8. [:SOURCE]:SIMulation:ABNormal:TIME .....	85
3-10-9. [:SOURCE]:SIMulation:ABNormal:VOLTAge .....	86
3-10-10. [:SOURCE]:SIMulation:CStEp .....	86
3-10-11. [:SOURCE]:SIMulation:INITial:CODE .....	87
3-10-12. [:SOURCE]:SIMulation:INITial:FREQuency .....	87
3-10-13. [:SOURCE]:SIMulation:INITial:PHASe:StARt:ENABle .....	88
3-10-14. [:SOURCE]:SIMulation:INITial:PHASe:StARt[:IMMediate] .....	88
3-10-15. [:SOURCE]:SIMulation:INITial:PHASe:StOP:ENABle .....	89
3-10-16. [:SOURCE]:SIMulation:INITial:PHASe:StOP[:IMMediate] .....	89
3-10-17. [:SOURCE]:SIMulation:INITial:VOLTAge .....	90
3-10-18. [:SOURCE]:SIMulation:NORMal<1 2>:CODE .....	90
3-10-19. [:SOURCE]:SIMulation:NORMal 1:FREQuency .....	91
3-10-20. [:SOURCE]:SIMulation:NORMal<1 2>:PHASe:StARt:ENABle .....	91
3-10-21. [:SOURCE]:SIMulation:NORMal<1 2>:PHASe:StARt[:IMMediate] .....	92
3-10-22. [:SOURCE]:SIMulation:NORMal<1 2>:PHASe:StOP:ENABle .....	92
3-10-23. [:SOURCE]:SIMulation:NORMal<1 2>:PHASe:StOP[:IMMediate] .....	93
3-10-24. [:SOURCE]:SIMulation:NORMal<1 2>:TIME .....	93
3-10-25. [:SOURCE]:SIMulation:NORMal1:VOLTAge .....	94
3-10-26. [:SOURCE]:SIMulation:REPEat:COUNt .....	94
3-10-27. [:SOURCE]:SIMulation:REPEat:ENABle .....	95
3-10-28. [:SOURCE]:SIMulation:TRANsition<1 2>:TIME .....	95
3-10-29. [:SOURCE]:SIMulation:TRANsition<1 2>:CODE .....	95
3-10-30. :TRIGger:SIMulation:SELEcted:EXECute .....	96
<b>3-11. Input Subsystem Command .....</b>	<b>97</b>
3-11-1. :INPut:GAIN .....	97

3-11-2. :INPut:SYNC:SOURce.....	97
<b>3-12. Display Command.....</b>	<b>98</b>
3-12-1. :DISPlay[:WINDow]:DESIgn:MODE .....	98
3-12-2. :DISPlay[:WINDow]:MEASure:SOURce<1 2 3> .....	98
<b>4. Status Register Overview .....</b>	<b>99</b>
4-1. Introduction to the Status Registers .....	99
4-2. The Status Registers.....	100
4-3. Questionable Status Register Group .....	101
4-4. Operation Status Register Group .....	104
4-5. Warning Status Register Group .....	106
4-6. System Lock Status Register Group.....	109
4-7. Standard Event Status Register Group.....	111
4-8. Status Byte Register & Service Request Enable Register .....	113
<b>5. Error List</b>	<b>115</b>
5-1. Command Errors.....	115
5-2. Execution Errors .....	117
5-3. Device Specific Errors.....	120
5-4. Query Errors.....	121
<b>6. APPENDIX.....</b>	<b>122</b>
6-1. Factory Default Settings .....	122





# 1. REMOTE CONTROL

This chapter describes basic configuration of IEEE488.2 based remote control.

---

## 1-1. Interface Configuration

### 1-1-1. Configure Ethernet Connection

The Ethernet interface can be configured for a number of different applications. Ethernet can be configured for basic remote control or monitoring using a web server or it can be configured as a socket server.



The ASR supports both DHCP connections so the instrument can be automatically connected to an existing network or alternatively, network settings can be manually configured.

---

Ethernet Parameters	MAC Address (display only)	DHCP
	IP Address	Subnet mask
	Gateway	DNS address
	DNS Server	Socket port fixed at 2268

---

#### Ethernet Configuration

1. Connect a LAN cable from the PC to the Ethernet port on the rear panel. 
2. Press the *Menu* key. The Menu setting will appear on the display. 
3. Use the scroll wheel to go to item 3, *LAN* and press *Enter*.
4. If the LAN cable is installed correctly a connection is active, the *Connection Status* will show *Online*.

5. To automatically have the network assign an IP address, set DHCP to ON. Otherwise set DHCP to OFF to manually set the Ethernet settings.

---

DHCP    ON, OFF

---

6. If DHCP was set to OFF, configure the remaining LAN parameters.

---

IP Address

---

Subnet Mask

---

Gateway

---

DNS Server

---

Socket Port

---



Note

Socket Port is fixed to 2268.

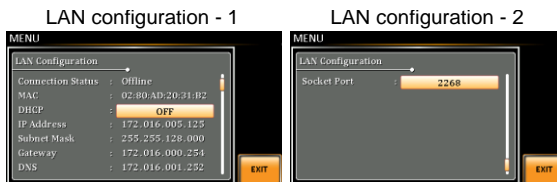

Exit

7. Press *Exit*[F4] to exit from the LAN settings.



Note

If connecting to an existing network, check the settings with your administrator.

---

## 1-1-2. Web Server Remote Control Function Check

---

### Functionality Check

Enter the IP address of the power supply (for example: http:// XXX.XXX.XXX.XXX) in a web browser after the instrument has been configured for LAN (page 1).

The web interface allows you to:

- View the system and information and the network configuration.
- View the analog control pinout.
- View the dimensions of the unit.
- View the operating area

Example:



<b>Welcome Page</b>	<b>Network Configuration</b>
	IP Address: 172.16.5.125
	Subnet Mask: 255.255.128.0
<b>Network Configuration</b>	Gateway: 172.16.0.254
	DNS: 172.16.1.252
<b>Analog Control</b>	DHCP State: <input type="radio"/> ON <input checked="" type="radio"/> OFF
<b>Figure of Dimensions</b>	Password: <input type="password"/>
<b>Operating Area</b>	<input type="button" value="Submit"/>

### 1-1-3. Socket Server Function Check

**Background** To test the socket server functionality, National Instruments Measurement and Automation Explorer can be used. This program is available on the NI website, [www.ni.com](http://www.ni.com), via a search for the VISA Run-time Engine page, or “downloads” at the following URL, <http://www.ni.com>

**Requirements** Operating System: Windows

**Functionality Check** 1. Start the NI Measurement and Automation Explorer (MAX) program. Using Windows, press:  
*Start>All Programs>NI MAX*

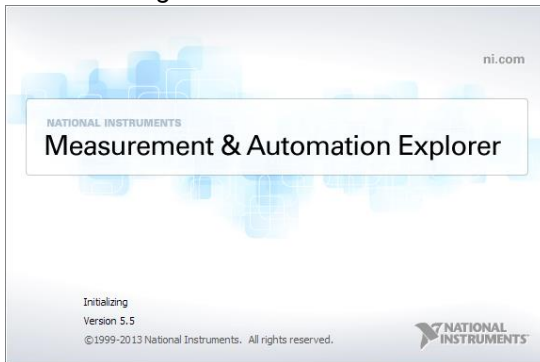

2. From the Configuration panel access; *My System>Devices and Interfaces>Network Devices*
3. Press *Add New Network Device>Visa TCP/IP Resource...*

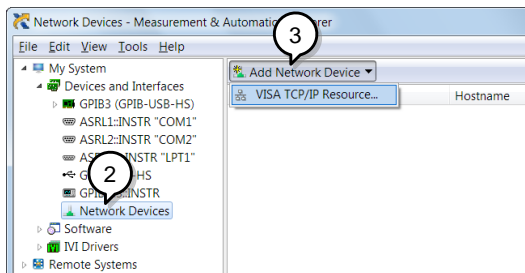

4. Select *Manual Entry of Raw Socket* from the popup window.

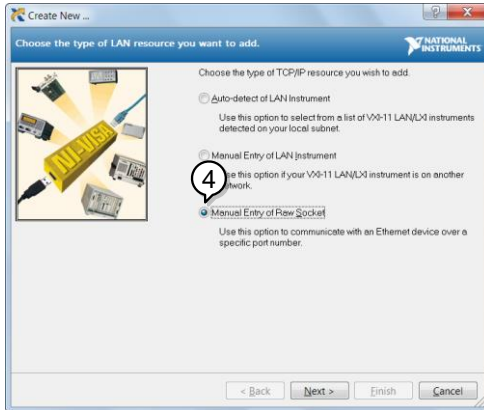

5. Enter the IP address and the port number of the ASR. The port number is fixed at 2268.
6. Double click the Validate button and press *Next*.

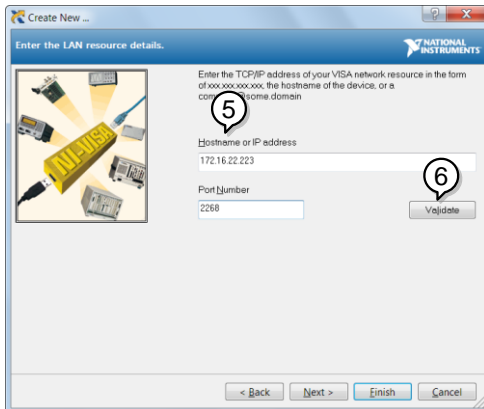

- Next configure the Alias (name) of the ASR connection. In this example the Alias is: ASR
- Click finish.

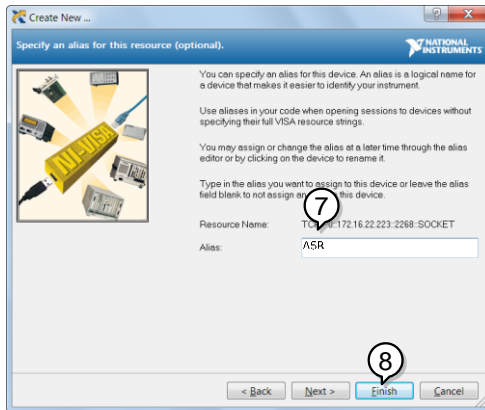

- The IP address of the power supply will now appear under Network Devices in the configuration panel. Select this icon now.
- Press *Open VISA Test Panel*.

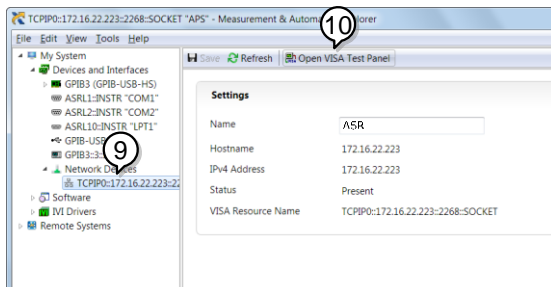

- Click the *Configuration* Icon. Under the *I/O Settings* tab check *Enable Termination Character*. The termination character should be set as *Line Feed -\n*.

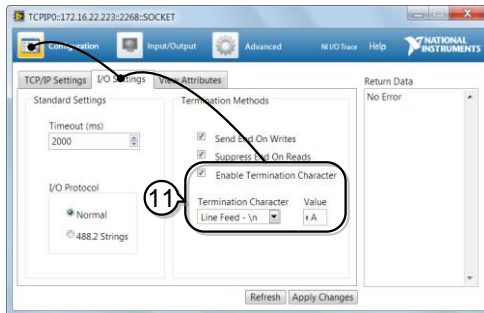

- Click the *Input/Output* icon. Under the *Basic I/O* tab, make sure *\*IDN?\n* is entered in the *Select or Enter Command* drop box.

- Click *Query*.

The ASR will return the machine identification string into the buffer area:

TEXIO TECHNOLOGY, ASRXXX-XXX,  
XXXXXXXXXX, XX.XX

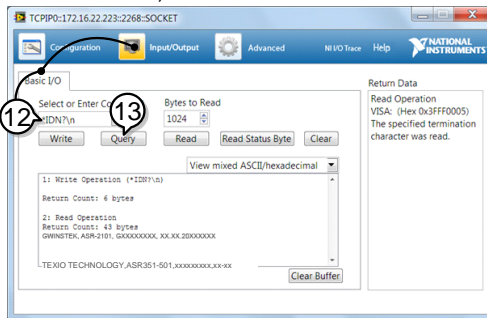

## 1-2.USB Interface

---

### 1-2-1. USB Remote Interface

---

USB Configuration	PC side connector	Type A, host
	ASR side connector	Rear panel Type B, slave
	Speed	1.1/2.0 (full speed)
	USB Class	CDC (communications device class)

---

#### Steps

1. Connect the Type A-Type B USB cable from the PC to the rear panel USB B port.



2. Press the *Menu* key. The Menu setting will appear on the display.



3. Use the scroll wheel to go to item 4, *USB Device* .

4. If the connection is successful *Connection Status* will change from Offline to Online.

#### Exit

5. Press *Exit[F4]* to exit from the rear panel USB settings.





## 1-2-2. USB Remote Control Function Check

---

**Functionality Check**      Invoke a terminal application such as Realterm. ASR will appear as a COM port on the PC. To check the COM settings in Windows, see the Device Manager. For example, in Win10 go to the Control panel → System → Hardware tab.

---



### Note

If you are not familiar with using a terminal application to send/receive remote commands via a USB connection, please see page 12 for more information.

---

Run this query command via the terminal after the instrument has been configured for USB remote control (page 8).

\*IDN?

This should return the Manufacturer, Model number, Serial number, and Software version in the following format.

TEXIO TECHNOLOGY, ASRXXX-XXX,  
XXXXXXXXXX, XX.XX

Manufacturer: TEXIO TECHNOLOGY

Model number : ASRXXX-XXX

Serial number : XXXXXXXXXXX

Software version : XX.XX

---

## 1-3.RS-232C Interface

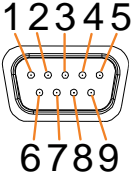

### 1-3-1. RS-232C Remote Interface

RS-232C Configuration	Connector Parameters	BD-9, male Baud rate, data bits, parity, stop bits.
-----------------------	----------------------	--

Pin Assignment		2: RxD (Receive data) 3: TxD (Transmit data) 5: GND 4, 6 ~ 9: No connection
----------------	---	--

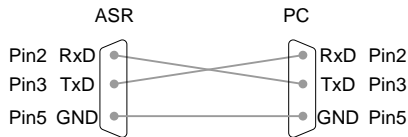
Pin Connection	Use a Null Modem connection (RS-232C cable) as shown in the diagram below.
----------------	--

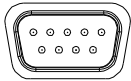

Steps	1. Connect the RS-232C cable from the PC to the rear panel RS-232 port.	 
	2. Press the <i>Menu</i> key. The Menu setting will appear on the display.	
	3. Use the scroll wheel to go to item 5, <i>RS232C</i> and press <i>Enter</i> .	
	4. Set the RS232C relative settings.	

Baud rate	1200, 2400, 4800, 9600(default), 19200, 38400, 57600, 115200,
Data bits	7 bits, 8 bits(default)
Parity	None(default), Odd, Even
Stop bits	1 bit(default), 2 bits

## RS232C Configuration



Exit

5. Press *Exit[F4]* to exit from the RS232C settings.



The standard accessory does Not include RS232C data cable. Please purchase the additional GTL-232 which will meet your need for RS232C connection.

### 1-3-2. RS-232C Remote Control Function Check

Functionality  
Check

Invoke a terminal application such as Realterm. For RS-232C, set the COM port, baud rate, stop bit, data bit and parity accordingly. To check the COM settings in Windows, see the Device Manager. For example, in Win10 go to the Control panel → System → Hardware tab.



If you are not familiar with using a terminal application to send/receive remote commands from the serial port, please see page 12 for more information.

Run this query command via the terminal after the instrument has been configured for RS-232C remote control (page 10).

\*IDN?

This should return the Manufacturer, Model number, Serial number, and Software version in the following format.

TEXIO TECHNOLOGY, ASRXXX-XXX,  
XXXXXXXXXX, XX.XX

Manufacturer: TEXIO TECHNOLOGY

Model number : ASRXXX-XXX

Serial number : XXXXXXXXXXXX

Software version : XX.XX

### 1-3-3. Using Realterm to Establish a Remote Connection

---

Background	<p>Realterm is a terminal program that can be used to communicate with a device attached to the serial port of a PC or via an emulated serial port via USB.</p> <p>The following instructions apply to version 2.0.0.70. Even though Realterm is used as an example to establish a remote connection, any terminal program can be used that has similar functionality.</p>
 Note	<p>Realterm can be downloaded on Sourceforge.net free of charge. For more information please see <a href="http://realterm.sourceforge.net/">http://realterm.sourceforge.net/</a></p>
Operation	<ol style="list-style-type: none"><li>1. Download Realterm and install according to the instructions on the Realterm website.</li><li>2. Connect the ASR via USB (page 8) or via RS-232 (page 10).</li><li>3. If using RS-232, make note of the configured baud rate, stop bits and parity.</li><li>4. Go to the Windows device manager and find the COM port number for the connection. For example, go to the Start menu &gt; Control Panel &gt; Device Manager. Double click the <i>Ports</i> icon to reveal the connected serial port devices and the COM port for the each connected device. If using USB, the baud rate, stop bit and parity settings can be viewed by right-clicking the connected device and selecting the <i>Properties</i> option.</li></ol>

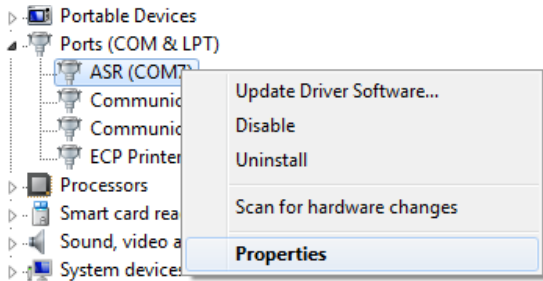

5. Start Realterm on the PC as an administrator.  
Click:  
Start menu>All Programs>RealTerm>realterm  
Tip: to run as an administrator, you can right click the Realterm icon in the Windows Start menu and select the *Run as Administrator* option.
6. After Realterm has started, click on the *Port* tab.  
Enter the *Baud*, *Parity*, *Data bits*, *Stop bits* and *Port* number configuration for the connection.  
The *Hardware Flow Control*, *Software Flow Control* options can be left at the default settings.
7. Press Open to connect to the ASR.

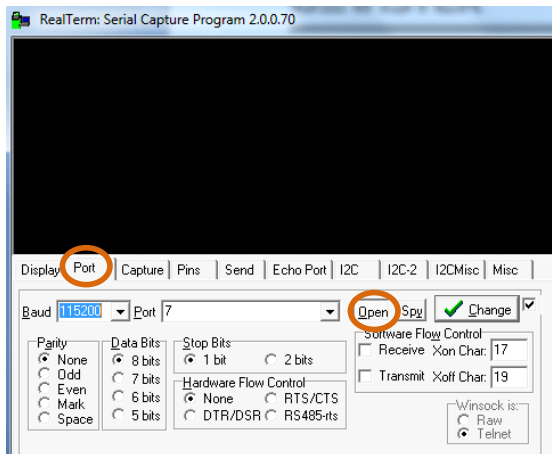

For USB, the baud rate should be fixed to 115,200.

8. Click on the *Send* tab.

In the *EOL* configuration, check on the *+LF* check boxes.

Enter the query:

*\*idn?*

Click on *Send ASCII*.

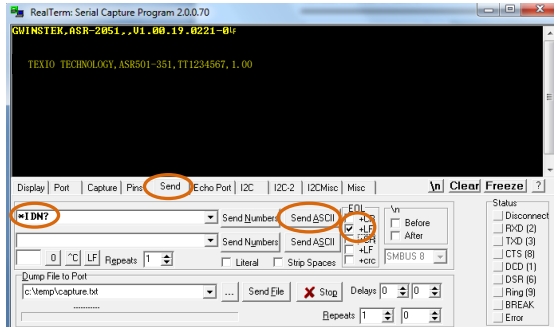

9. The terminal display will return the following:

TEXIO TECHNOLOGY, ASRXXX-XXX,  
XXXXXXXXXX, XX.XX

(manufacturer, model, serial number, software version)

10. If Realterm fails to connect to the ASR, please check all the cables and settings and try again.

## 1-4.GP-IB Interface

### 1-4-1. GPIB Remote Interface

#### GPIB Configuration

1. Connect a GPIB cable from the PC to the GPIB port on the rear panel.
2. Press the *Menu* key. The Menu setting will appear on the display.
3. Use the scroll wheel to go to item 6, *GPIB* and press *Enter*.
4. Set the GPIB address.

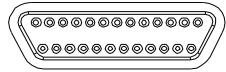

GPIB Address      0 ~ 30 (10 by default)

#### GPIB Configuration

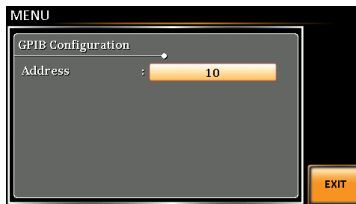

Note

Only one GPIB address can be used at a time.

Exit

5. Press *Exit[F4]* to exit from the GPIB settings.



#### GPIB Constraints

- Maximum 15 devices altogether, 20m cable length, 2m between each device
- Unique address assigned to each device
- At least 2/3 of the devices turned On
- No loop or parallel connection

## 1-4-2. GPIB Function Check

---

Functionality Check Please use the National Instruments NI-488.2 (Measurement & Automation Controller software) to confirm GPIB functionality.

See the National Instrument website, <http://www.ni.com> for details.



Note

- Operating System: Windows

---

Operation

1. Start the NI Measurement and Automation Explorer (MAX) program. Using Windows, press:



---

*Start>All Programs>NI MAX*

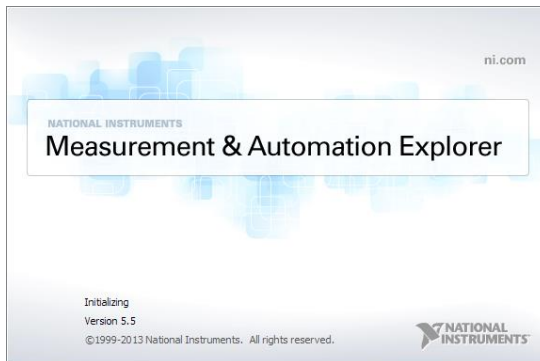

2. From the Configuration panel access;  
*My System>Devices and Interfaces>GPIB0*



3. Press the *Scan for Instruments* button.
4. In the *Connected Instruments* panel the ASR should be detected as *Instrument 0* with the address the same as that configured on the ASR.
5. Double click the *Instrument 0* icon.

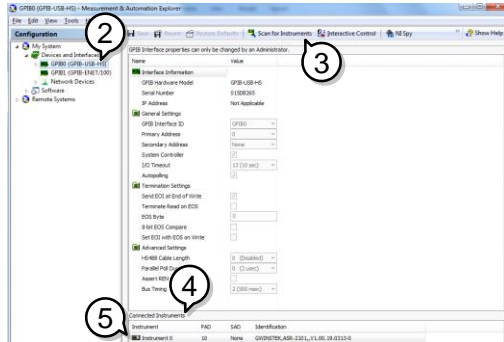

6. Click on *Communicate with Instrument*.
7. Under the Communicator tab, ensure *\*IDN?* is written in the *Send String* text box.
8. Click on the *Query* button to send the *\*IDN?* query to the instrument.
9. The instrument identification string will be returned to the buffer area:

TEXIO TECHNOLOGY, ASRXXX-XXX,  
XXXXXXXXXX, XX.XX

(manufacturer, model, serial number, software version)

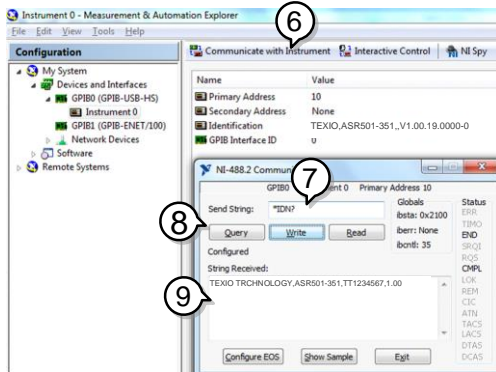

10. The function check is complete.

## 2. Command Syntax

Compatible Standard	IEEE488.2 SCPI, 1999	Partial compatibility Partial compatibility
Command Structure	<p>SCPI commands follow a tree-like structure, organized into nodes. Each level of the command tree is a node. Each keyword in a SCPI command represents each node in the command tree. Each keyword (node) of a SCPI command is separated by a colon (:).</p> <p>For example, the diagram below shows an SCPI sub-structure and a command example.</p>	

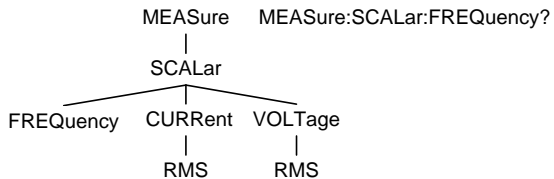

Command types	<p>There are a number of different instrument commands and queries. A command sends instructions or data to the unit and a query receives data or status information from the unit.</p>
---------------	---

### Command types

Simple	A single command with/without a parameter
Example	*IDN?
Query	A query is a simple or compound command followed by a question mark (?). A parameter (data) is returned.
Example	meas:curr?
Compound	<p>Two or more commands on the same command line. Compound commands are separated with either a semi-colon (;) or a semi-colon and a colon (;:).</p> <p>A semi-colon is used to join</p>



Note  
(Further  
explanation)

---

two related commands, with the caveat that the last command must begin at the last node of the first command.

Example      `meas:volt?;curr?`  
 A semi-colon and colon are used to combine two commands from different nodes.

Example      `meas:volt?::sour:volt?`

---

A semi-colon(;) is used to connect two commands. A colon(:) at the start of a command indicates that the command starts from the root node. The first command can ignore that first colon. Any commands after the first command (for compound commands) that do not begin with a colon, must begin at the last node of the first command.

---

Command  
Forms

Commands and queries have two different forms, long and short. The command syntax is written with the short form of the command in capitals and the remainder (long form) in lower case.

The commands can be written in capitals or lower-case, just so long as the short or long forms are complete. An incomplete command will not be recognized.

Below are examples of correctly written commands.

---

Long form	<code>:SYSTem:ERRor?</code>
	<code>:SYSTEM:ERROR?</code>
	<code>:system:error?</code>

---

Short form	<code>SYST:ERR?</code>
	<code>syst:err?</code>

---

Square Brackets	<p>Commands that contain square brackets indicate that the contents are optional. The function of the command is the same with or without the square bracketed items, as shown below.</p> <p>For example the query “:OUTPut[:STATe]?” has two valid forms, “:OUTPut:STATe?” and “:OUTPut?”.</p>		
Command Format		<ol style="list-style-type: none"> <li>1. Command header</li> <li>2. Space</li> <li>3. Parameter 1</li> <li>4. Comma (no space before/after comma)</li> <li>5. Parameter 2</li> </ol>	
Parameters	Type	Description	Example
	<Boolean>	Boolean logic	0, 1
	<NR1>	integers	0, 1, 2, 3
	<NR2>	decimal numbers	0.1, 3.14, 8.5
	<NR3>	floating point	4.5e-1, 8.25e+1
	<NRf>	any of NR1, 2, 3	1, 1.5, 4.5e-1
	<block data>	Definitive length arbitrary block data. A single decimal digit followed by data. The decimal digit specifies how many 8-bit data bytes follow.	
About the return parameters of ASR series.	<bool>	+0,+1	
	<NR1>	The number with a + sign.	
	<NR2>	The number with a + or -sign. The number after the decimal point is fixed at 4 digits. There are exceptions, so check each command.	
Message Terminator	LF	Line feed code (0x0A)	

### 3.

## 3. Command List

---

### 3-1. Common Commands

---

#### 3-1-1. \*CLS

Set →

Description The \*CLS command clears all the event registers, including the status byte, event status and error queue.

---

Syntax \*CLS

---

#### 3-1-2. \*ESE

Set →  
→ Query

Description Sets or queries the Standard Event Status Enable register.

---

Syntax \*ESE<NR1>

Query Syntax \*ESE?

---

parameter <NR1> 0 ~ 255

---

Return parameter <NR1> Returns the bit sum of the Standard Event Status Enable register.

---

#### 3-1-3. \*ESR

→ Query

Description Queries the Standard Event Status (Event) register. The Event Status register is cleared after it is read.

---

Query Syntax \*ESR?

---

Return parameter <NR1> Returns the bit sum of the Standard Event Status (Event) register and clears the register.

---

### 3-1-4. \*IDN

→ Query

Description	Queries the manufacturer, model name, serial number, and firmware version of the ASR.
Query Syntax	*IDN?
Return parameter	<string> Returns the instrument identification as a string in the following format: TEXIO TECHNOLOGY,ASRXXX-XXX,XXXXXXXXXX,XX.XX Manufacturer: TEXIO TECHNOLOGY Model number : ASRXXX-XXX Serial number : XXXXXXXXXX Firmware version : XX.XX

### 3-1-5. \*OPC

→ Query

Description	The *OPC? Query returns 1 when all the outstanding commands have completed.
Syntax	*OPC
Query Syntax	*OPC?
Return parameter	1 Returns 1 when all the outstanding commands have completed.

### 3-1-6. \*RCL

Set →

Description	Recalls the contents stored in memory slot M0 ~ M9. These memory slots are mapped to the preset settings.
Syntax	*RCL {<NR1> MINimum MAXimum}
Parameter	<NR1> 0 ~ 9 (as memory M0 ~ M9) MIN Recalls the M0 memory contents. MAX Recalls the M9 memory contents.

### 3-1-7. \*RST

Set →

---

Description	Performs a device reset. Configures the unit to a known configuration (default settings). This known configuration is independent of the usage history.
Syntax	*RST

---

### 3-1-8. \*SAV

Set →

---

Description	Saves the settings into memory slot M0 ~ M9. These memory slots are mapped to the preset settings.
Syntax	*SAV {<NR1> MINimum MAXimum}
Return parameter	<NR1> 0 ~ 9 (as memory M0 ~ M9)
	MIN Saves to the M0 memory slot.
	MAX Saves to the M9 memory slot.

---

### 3-1-9. \*SRE

Set →  
→ Query

---

Description	Sets or queries the Service Request Enable register. The Service Request Enable register determines which registers of the Status Byte register are able to generate service requests.
Syntax	*SRE<NR1>
Query Syntax	*SRE?
Parameter	<NR1> 0 ~ 255
Return parameter	<NR1> Returns the bit sum of the Service Request Enable register.

---



### 3-1-10. \*STB

→ Query

---

Description	Queries the bit sum of the Status Byte register with MSS (Master summary Status) replacing the RQS bit (bit 6).
Query Syntax	*STB?
Return parameter	<NR1> Returns the bit sum of the Status Byte register with the MSS bit (bit 6).

---

### 3-1-11. \*WAI

Set →

---

Description	Prevents any other commands or queries from being executed until all outstanding commands have completed.
Syntax	*WAI

---

## 3-2.Trace/Data Commands



Note

The TRACE and DATA node for the following commands are functionally equivalent.

### 3-2-1. :DATA|TRACe:SEQuence:CLEAr

Set →

---

Description	Clears the sequence data for the selected save memory (Seq0 ~ Seq9).
Syntax	:DATA TRACe:SEQuence:CLEAr {<NR1> MINimum MAXimum}
Parameter	<NR1> 0~9 MIN 0 MAX 9
Example	:DATA:SEQ:CLE 1 Clears the sequence data from Seq1.

### 3-2-2. :DATA|TRACe:SEQuence:RECall

Set →

---

Description	Loads the sequence data. This command is the equivalent to recalling a sequence memory in the Sequence mode.
Syntax	:DATA TRACe:SEQuence:RECall {<NR1> MINimum MAXimum}
Parameter	<NR1> 0~9 (Seq0 ~ Seq9). MIN 0 MAX 9
Example	:DATA:SEQ:REC 1 Loads the data from Seq1.

### 3-2-3. :DATA|TRACe:SEQuence:StORe

Set →

**Description** Saves the sequence data. This command is the equivalent to saving a sequence memory in Sequence mode.

**Syntax** :DATA|TRACe:SEQuence:StORe  
{<NR1>|MINimum|MAXimum}

**Parameter** <NR1> 0~9 (Seq0 ~ Seq9).  
MIN 0  
MAX 9

**Example** :DATA:SEQ:StOR 1  
Saves the data from Seq1.

### 3-2-4. :DATA|TRACe:SIMulation:CLear

Set →

**Description** Clears the simulation data for the selected save memory (SIM0 ~ SIM9).

**Syntax** :DATA|TRACe:SIMulation:CLear  
{<NR1>|MINimum|MAXimum}

**Parameter** <NR1> 0~9 (SIM0 ~ SIM9).  
MIN 0  
MAX 9

**Example** :DATA:SIM:CLE 1  
Clears the simulation data from SIM1.

### 3-2-5. :DATA|TRACe:SIMulation:RECall

Set →

---

Description Loads the simulation data. This command is the equivalent to recalling a simulation memory in the Simulation mode (SIM0~SIM9).

---

Syntax :DATA|TRACe:SIMulation:RECall  
{<NR1>|MINimum|MAXimum}

---

Parameter <NR1> 0~9 (SIM0 ~ SIM9).  
MIN 0  
MAX 9

---

Example :DATA:SIM:REC 1  
Loads the data from SIM1.

### 3-2-6. :DATA|TRACe:SIMulation:STORe

Set →

---

Description Saves the simulation data. This command is the equivalent saving a simulation memory in Simulation mode (SIM0 ~ SIM9).

---

Syntax :DATA|TRACe:SIMulation:STORe  
{<NR1>|MINimum|MAXimum}

---

Parameter <NR1> 0~9 (SIM0 ~ SIM9).  
MIN 0  
MAX 9

---

Example :DATA:SIM:STOR 1  
Saves the data from SIM1.

### 3-2-7. :DATA|TRACe:WAVe:CLEar

Set →

**Description** Clears the ARB 1-16 data for the selected wave group.

**Syntax** :DATA|TRACe:WAVe:CLEar  
{<NR1>|MINimum|MAXimum}

**Parameter**

<NR1>	1~16 (ARB1 ~ ARB16).
MIN	Minimum
MAX	Maximum

**Example** :DATA:WAV:CLE 13  
Clears the wave data from ARB13.

### 3-2-8. :DATA|TRACe:WAVe[:DATA]

Set →

**Description** Sets the arbitrary wave.

**Syntax** :DATA|TRACe:WAVe[:DATA] {<NR1>|<Binary Data>}

**Parameter**

<NR1>	1 – 16 (ARB 1 – 16)
Binary Data includes the #48192<DAB>...<DAB>	
#	Indicates the block data is sent.
4	Indicates the number of subsequent numbers.
8192	Indicates the number of subsequent byte data.
<DAB>.. >	Indicates 16-bit with 4096 words waveform data. Plus, the data format of wave is the big endian in the form of two's complement.

**Example** TRAC:WAV 1, #48192<DAB>...<DAB>

## 3-3.Measure Commands

---

### 3-3-1. :MEASure[:SCALar]:CURRent:CFACtor → Query

---

Description	Returns the output current crest factor (CF).
Query syntax	:MEASure[:SCALar]:CURRent:CFACtor?
Return parameter	<NR2> Returns the crest factor.

### 3-3-2. :MEASure[:SCALar]:CURRent:HIGH → Query

---

Description	Returns the output current maximum peak value (Imax).
Note:	Current maximum peak value is defined as the highest peak value in the complete period.
Query syntax	:MEASure[:SCALar]:CURRent:HIGH?
Return parameter	<NR2> Returns the Imax value in amps.

### 3-3-3. :MEASure[:SCALar]:CURRent:LOW → Query

---

Description	Returns the output current minimum value (Imin).
Note:	Current minimum value is defined as the lowest value in the complete period.
Query syntax	:MEASure[:SCALar]:CURRent:LOW?
Return parameter	<NR2> Returns the Imin value in amps.

### 3-3-4. :MEASure[:SCALar]:CURRent:PEAK:CLEar Set →

---

Description	Clears the current peak-hold value.
Syntax	:MEASure[:SCALar]:CURRent:PEAK:CLEar

### 3-3-5. :MEASure[:SCALar]:CURRent:PEAK: HOLD

→ Query

---

Description	Returns the current peak hold value in amps (IPK Hold).
Query syntax	:MEASure[:SCALar]:CURRent:PEAK:HOLD?
Return	<NR2> Returns the peak hold value in amps.

---

### 3-3-6. :MEASure[:SCALar]:CURRent[:RMS]

→ Query

---

Description	Returns the output current (Irms).
Query syntax	:MEASure[:SCALar]:CURRent[:RMS]?
Return	<NR2> Returns the Irms value.

---

### 3-3-7. :MEASure[:SCALar]:CURRent:AVERAge

→ Query

---

Description	Returns the current average value (Iavg).
Query syntax	:MEASure[:SCALar]:CURRent:AVERAge?
Return	<NR2> Returns the current average value in amps.

---

### 3-3-8. :MEASure[:SCALar]:CURRent:HARMonic [:RMS]

→ Query

---

Description	Returns 101 values covering Total and order 1 to 100 current (Irms) in harmonic. (Only AC-INT and 50 /60 Hz Active)
Query syntax	:MEASure[:SCALar]:CURRent:HARMonic[:RMS]?
Return	<NR2>,<NR2 >,<NR2>...,<NR2> etc. Returns the entire 101 values containing Total and order 1 to 100 current (Irms) in harmonic.

---

### 3-3-9. :MEASure[:SCALar]:CURRent:HARMonic: RATio

→ Query

---

Description Returns 101 values covering Total and order 1 to 100 current (Ratio) in harmonic. (Only AC-INT and 50 /60 Hz Active)

---

Query syntax :MEASure[:SCALar]:CURRent:HARMonic:RATio?

---

Return <NR2>,<NR2> Returns the entire 101 values containing Total and order 1 to 100 current (Ratio) in harmonic.  
>,<NR2>,  
<NR2>...,  
etc.

### 3-3-10.:MEASure[:SCALar]:FREQuency

→ Query

---

Description Returns the SYNC signal source frequency in Hz. (Only AC+DC-sync or AC-sync Active)

---

Query syntax :MEASure[:SCALar]:FREQuency?

---

Return <NR2> Returns the SYNC frequency in Hz.

### 3-3-11.:MEASure[:SCALar]:POWer[:AC]: APParent

→ Query

---

Description Returns the apparent power (S).

---

Query syntax :MEASure[:SCALar]:POWer[:AC]:APParent?

---

Return <NR2> Returns the apparent power in VA.

### 3-3-12.:MEASure[:SCALar]:POWer[:AC]:PFACTOR

→ Query

---

Description Returns the power factor (PF).

---

Query syntax :MEASure[:SCALar]:POWer[:AC]:PFACTOR?

---

Return <NR2> Returns the power factor.



### 3-3-13. :MEASure[:SCALar]:POWER[:AC]: REActive

→ [Query](#)

---

Description	Returns the reactive power (Q).
Query syntax	:MEASure[:SCALar]:POWER[:AC]:REActive?
Return	<NR2> Returns the reactive power in VAR.

---

### 3-3-14. :MEASure[:SCALar]:POWER[:AC][:REAL]

→ [Query](#)

---

Description	Returns the active power in Watts (P).
Query syntax	:MEASure[:SCALar]:POWER[:AC][:REAL]?
Return	<NR2> Returns the power in Watts.

---

### 3-3-15. :MEASure[:SCALar]:VOLTage[:RMS]

→ [Query](#)

---

Description	Returns the voltage (Vrms).
Query syntax	:MEASure[:SCALar]:VOLTage[:RMS]?
Return	<NR2> Returns the voltage in Vrms.

---

### 3-3-16. :MEASure[:SCALar]:VOLTage:AVERage

→ [Query](#)

---

Description	Returns the voltage average value (Vavg).
Query syntax	:MEASure[:SCALar]:VOLTage:AVERage?
Return	<NR2> Returns the voltage average value in volts.

---

### 3-3-17.:MEASure[:SCALar]:VOLTage:HIGH → Query

Description Returns the output voltage maximum peak value (Vmax).

Note: Voltage maximum peak value is defined as the highest peak value in the complete period.

Query syntax :MEASure[:SCALar]:VOLTage:HIGH?

Return parameter <NR2> Returns the Vmax value in volts.

### 3-3-18.:MEASure[:SCALar]:VOLTage:LOW → Query

Description Returns the output current minimum value (Vmin).

Note: Voltage minimum value is defined as the lowest value in the complete period.

Query syntax :MEASure[:SCALar]:VOLTage:LOW?

Return parameter <NR2> Returns the Vmin value in volts.

### 3-3-19.:MEASure[:SCALar]:VOLTage:HARMonic[:RMS] → Query

Description Returns 101 values covering Total and order 1 to 100 voltage (Vrms) in harmonic. (Only AC-INT and 50 /60 Hz Active)

Query syntax :MEASure[:SCALar]: VOLTage:HARMonic[:RMS]?

Return <NR2>,<NR2>,<NR2>,<NR2>... etc. Returns the entire 101 values containing Total and order 1 to 100 voltage (Vrms) in harmonic.

3-3-20. :MEASure[:SCALar]:VOLTage:HARMonic:  
RATio

→ Query

Description	Returns 101 values covering Total and order 1 to 100 voltage (Ratio) in harmonic. (Only AC-INT and 50 /60 Hz Active)
Query syntax	:MEASure[:SCALar]: VOLTage:HARMonic:RATio?
Return	<NR2>,<NR2 Returns the entire 101 values >,<NR2>, containing Total and order 1 to 100 <NR2>..., voltage (Ratio) in harmonic. etc.

3-3-21. :MEASure:CONFIgure:SENSing

Set →

→ Query

Description	Sets or queries the remote sense configuration. (Only AC-INT, DC-INT, AC-SYNC Mode and 100V, 200V Range and SIN Wave Shape and Time Slew Rate Mode Active)
Syntax	:MEASure:CONFIgure:SENSing {<bool> OFF ON}
Query syntax	:MEASure:CONFIgure:SENSing?
Parameter	OFF   0 Turns the remote sense off. ON   1 Turns the remote sense on. <bool> Returns the status of remote sense.
Example	:MEAS:CONF:SENS 0 Sets the remote sense off.

### 3-3-22. :MEASure:AVERage:COUNT

Set →  
→ Query

---

Description	Sets or queries the average count of measurements.	
Syntax	:MEASure:AVERage:COUNT {<NR1>   MINimum   MAXimum}	
Query syntax	:MEASure:AVERage:COUNT?	
Parameter	<NR1> MINimum MAXimum	1~128 Average count value 1 128
Return	<NR1>	Returns the average count value.
Example	:MEAS:AVER:COUN 10 Sets the average count 10.	

### 3-3-23. :MEASure:UPDate:RATE

Set →  
→ Query

---

Description	Sets or queries the measurement update rate.	
Syntax	:MEASure:UPDate:RATE {FAST   0.1   0.25   0.5   1   2   5   10   20}	
Query Syntax	:MEASure:UPDate:RATE?	
Parameter	FAST	Fastest update rate
Return parameter	<NR2>	0.1   0.25   0.5   1   2   5   10   20 sec
Example	:MEAS:UPD:RATE 2 Set the update rate to 2 seconds.	

---

## 3-4.Memory Commands

---

### 3-4-1. :MEMory:RCL

Set →

---

Description      Recalls the settings from memory slot M0~M9. These memory slots are mapped to the preset settings. Equivalent to the \*RCL command.

---

Syntax            :MEMory:RCL {<NR1>|MINimum|MAXimum}

---

Parameter        <NR1>        0~9  
                  MINimum        0  
                  MAXimum        9

---

Example            :MEMory:RCL  
                      Recall the settings to M1.

### 3-4-2. :MEMory:SAV

Set →

---

Description      Saves the settings into memory slot M0 ~ M9. These memory slots are mapped to the preset settings. Equivalent to the \*SAV command.

---

Syntax            :MEMory:SAV {<NR1>|MINimum|MAXimum}

---

Parameter        <NR1>        0~9  
                  MINimum        0  
                  MAXimum        9

---

Example            :MEMory:SAV 1  
                      Save the settings to M1.

## 3-5. Output Commands

### 3-5-1. :OUTPut[:STATe]

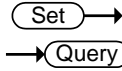

Description	Sets or queries the output state of power source.	
Syntax	:OUTPut[:STATe] {<bool> OFF ON}	
Query Syntax	:OUTPut[:STATe]?	
Parameter	OFF   0	Turns the output off.
	ON   1	Turns the output on.
Return parameter	<bool>	Returns output status of the instrument.
Example	:OUTP 0 Sets power output off.	

### 3-5-2. :OUTPut:PON

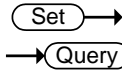

Description	Sets the output state at power-on.	
Syntax	:OUTPut:PON {<NR1> OFF ON SEQ SIM}	
Return Syntax	:OUTPut:PON?	
Parameter	<NR1> 0 ~ 3	
	OFF   0	Disabled
	ON   1	Enabled
	SEQ   2	Sequence function
	SIM   3	Simulate function
Return parameter	<NR1>	Returns the selected output state at power-on from 0 to 3.
Example	:OUTPut:PON 2 Sets sequence function on at power-on.	

### 3-5-3. :OUTPut:PROTection:CLEar

Set →

Description Clears the machine error.

Syntax :OUTPut:PROTection:CLEar

### 3-5-4. :OUTPut:RELAy

Set →

→ Query

Description Sets or queries the output relay of power source.

Syntax :OUTPut:RELAy {<bool>|OFF|ON}

Query Syntax :OUTPut:RELAy?

Parameter	OFF   0	Turns the output relay off.
	ON   1	Turns the output relay on.

Return parameter	<bool>	Returns output relay of the instrument.
------------------	--------	---

Example :OUTP:REL 1  
Sets output relay on.

## 3-6.Status Commands

---

### 3-6-1. :STATus:OPERation:CONDition

→ Query

Description Queries the Operation Status register. This query will not clear the register.

---

Query Syntax :STATus:OPERation:CONDition?

---

Return parameter <NR1> Returns the bit sum of the Operation Condition register. (+0 ~ +32767)

### 3-6-2. :STATus:OPERation:ENABLE

Set →

→ Query

Description Sets or queries the bit sum of the Operation Status Enable register.

---

Syntax :STATus:OPERation:ENABLE <NR1>

Query Syntax :STATus:OPERation:ENABLE?

---

Parameter <NR1> 0 ~ 32767

---

Return parameter <NR1> +0 ~ +32767

### 3-6-3. :STATus:OPERation[:EVENT]

→ Query

Description Queries the Operation Status Event register and clears the contents of the register.

---

Query Syntax :STATus:OPERation[:EVENT]?

---

Return parameter <NR1> Returns the bit sum of the Operation Status Event register.

### 3-6-4. :STATus:OPERation:NTRansition

Set →

→ Query

Description Sets or queries the bit sum of the negative transition filter of the Operation Status register.

---



Syntax	:STATus:OPERation:NTRansition <NR1>	
Query Syntax	:STATus:OPERation:NTRansition?	
Parameter	<NR1>	0 ~ 32767
Return parameter	<NR1>	+0 ~ +32767

### 3-6-5. :STATus:OPERation:PTRansition

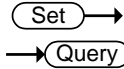

Description	Sets or queries the bit sum of the positive transition filter of the Operation Status register.	
Syntax	:STATus:OPERation:PTRansition <NR1>	
Query Syntax	:STATus:OPERation:PTRansition?	
Parameter	<NR1>	0 ~ 32767
Return parameter	<NR1>	+0 ~ +32767

### 3-6-6. :STATus:QUEStionable[:EVENT]



Description	Queries the bit sum of the Questionable Status Event register. This query will also clear the contents of the register.	
Query Syntax	:STATus:QUEStionable[:EVENT]?	
Return parameter	<NR1>	+0 ~ +32767

### 3-6-7. :STATus:QUEStionable:CONDition



Description	Queries the status (bit sum) of the Questionable Status register. This query will not clear the register.	
Query Syntax	:STATus:QUEStionable:CONDition?	
Return parameter	<NR1>	+0 ~ +32767

### 3-6-8. :STATus:QUEStionable:ENABle

Set →  
→ Query

---

Description      Sets or queries the bit sum of the Questionable Status Enable register.

---

Syntax            :STATus:QUEStionable:ENABle <NR1>

Query Syntax     :STATus:QUEStionable:ENABle?

---

Parameter        <NR1>    0 ~ 32767

---

Return parameter   <NR1>    +0 ~ +32767

---

### 3-6-9. :STATus:QUEStionable:NTRansition

Set →  
→ Query

---

Description      Sets or queries the bit sum of the negative transition filter of the Questionable Status register.

---

Syntax            :STATus:QUEStionable:NTRansition <NR1>

Query Syntax     :STATus:QUEStionable:NTRansition?

---

Parameter        <NR1>    0 ~ 32767

---

Return parameter   <NR1>    +0 ~ +32767

---

### 3-6-10.:STATus:QUEStionable:PTRansition

Set →  
→ Query

---

Description      Sets or queries the bit sum of the positive transition filter of the Questionable Status register.

---

Syntax            :STATus:QUEStionable:PTRansition <NR1>

Query Syntax     :STATus:QUEStionable:PTRansition?

---

Parameter        <NR1>    0 ~ 32767

---

Return parameter   <NR1>    +0 ~ +32767

---

**Description** This command resets the ENABLE register, the PTRansition filter and NTRansition filter on the Operation Status, Questionable Status, Warning Status and System Lock Status Registers. The registers/filters will be reset to a default value.

Default Register/Filter Values	Setting
QUESTionable Status Enable	0x0000
QUESTionable Status Positive Transition	0x7FFF
QUESTionable Status Negative Transition	0x0000
Operation Status Enable	0x0000
Operation Status Positive Transition	0x7FFF
Operation Status Negative Transition	0x0000
WARNing Status Enable	0x0000
WARNing Status Positive Transition	0x7FFF
WARNing Status Negative Transition	0x0000
System Lock Status Enable	0x0000
System Lock Status Positive Transition	0x7FFF
System Lock Status Negative Transition	0x0000

**Summary:** The Questionable Status Enable registers, the Operation Status Enable registers, Warning Status registers and System Lock Status registers are both reset to 0.

The Questionable Status, Operation Status, Warning Status and System Lock Status Positive Transition filters are all set high (0x7FFF) and the Negative Transition filters are all set low (0x0000). I.e., only positive transitions will be recognized for the Questionable Status, Operation Status, Warning Status and System Lock Status registers.

**Syntax** :STATus:PRESet

### 3-6-12.:STATus:WARNing:CONDition

→ Query

Description Queries the Warning Status register. This query will not clear the register.

Query Syntax :STATus:WARNing:CONDition?

Return parameter <NR1> Returns the bit sum of the Warning Condition register. (+0 ~ +32767)

Set →

### 3-6-13.:STATus:WARNing:ENABLE

→ Query

Description Sets or queries the bit sum of the Warning Status Enable register.

Syntax :STATus:WARNing:ENABLE <NR1>

Query Syntax :STATus:WARNing:ENABLE?

Parameter <NR1> 0 ~ 32767

Return parameter <NR1> +0 ~ +32767

### 3-6-14.:STATus:WARNing[:EVENT]

→ Query

Description Queries the Warning Status Event register and clears the contents of the register.

Query Syntax :STATus:WARNing[:EVENT]?

Return parameter <NR1> Returns the bit sum of the Warning Status Event register.

### 3-6-15. :STATus:WARNing:NTRansition

Set →  
→ Query

---

Description	Sets or queries the bit sum of the negative transition filter of the Warning Status register.
-------------	---

---

Syntax	:STATus:WARNing:NTRansition <NR1>
--------	-----------------------------------

Query Syntax	:STATus:WARNing:NTRansition?
--------------	------------------------------

---

Parameter	<NR1>	0 ~ 32767
-----------	-------	-----------

---

Return parameter	<NR1>	+0 ~ +32767
------------------	-------	-------------

---

### 3-6-16. :STATus:WARNing:PTRansition

Set →  
→ Query

---

Description	Sets or queries the bit sum of the positive transition filter of the Warning Status register.
-------------	---

---

Syntax	:STATus:WARNing:PTRansition <NR1>
--------	-----------------------------------

Query Syntax	:STATus:WARNing:PTRansition?
--------------	------------------------------

---

Parameter	<NR1>	0 ~ 32767
-----------	-------	-----------

---

Return parameter	<NR1>	+0 ~ +32767
------------------	-------	-------------

---

### 3-6-17. :STATus:LOCK:CONDition

→ Query

---

Description	Queries the System Lock Status register. This query will not clear the register.
-------------	--

---

Query Syntax	:STATus:LOCK:CONDition?
--------------	-------------------------

---

Return parameter	<NR1>	Returns the bit sum of the System Lock Status register. (+0 ~ +32767)
------------------	-------	---

---

### 3-6-18.:STATus:LOCK:ENABLE

Set →  
→ Query

---

Description	Sets or queries the bit sum of the System Lock Status Enable register.	
Syntax	:STATus:LOCK:ENABLE <NR1>	
Query Syntax	:STATus:LOCK:ENABLE?	
Parameter	<NR1>	0 ~ 32767
Return parameter	<NR1>	+0 ~ +32767

---

### 3-6-19.:STATus:LOCK[:EVENT]

→ Query

---

Description	Queries the System Lock Status Event register and clears the contents of the register.	
Query Syntax	:STATus:LOCK [:EVENT]?	
Return parameter	<NR1>	Returns the bit sum of the System Lock Status Event register.

---

### 3-6-20.:STATus:LOCK:NTRansition

Set →  
→ Query

---

Description	Sets or queries the bit sum of the negative transition filter of the System Lock Status register.	
Syntax	:STATus:LOCK:NTRansition <NR1>	
Query Syntax	:STATus:LOCK:NTRansition?	
Parameter	<NR1>	0 ~ 32767
Return parameter	<NR1>	+0 ~ +32767

---

### 3-6-21.:STATus:LOCK:PTRansition

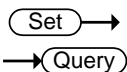

---

Description	Sets or queries the bit sum of the positive transition filter of the System Lock Status register.	
Syntax	:STATus:LOCK:PTRansition <NR1>	
Query Syntax	:STATus:LOCK:PTRansition?	
Parameter	<NR1>	0 ~ 32767
Return parameter	<NR1>	+0 ~ +32767

## 3-7. System Function Commands

### 3-7-1. :SYSTem:ACIN:DETection

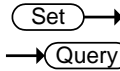

Description	Sets or queries AC input detection on/off.	
Syntax	:SYSTem:ACIN:DETection {<bool> OFF ON}	
Query Syntax	:SYSTem:ACIN:DETection?	
Parameter	OFF   0	Turns the AC input detection off.
	ON   1	Turns the AC input detection on.
Return parameter	<bool>	Returns the AC input detection status.

### 3-7-2. :SYSTem:ARBITrary:EDIT:BUILtin

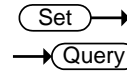

Description	Sets or queries the built in function of arbitrary edit	
Syntax	:SYSTem:ARBITrary:EDIT:BUILtin TRlangle   STAir	
Query Syntax	CLIP   CFACtor1   CFACtor2   SURGe   DST<01 22>	
	:SYSTem:ARBITrary:EDIT:BUILtin?	
Parameter / Return parameter	TRlangle	Built In Triangle Wave Function
	STAir	Built In Stair Wave Function
	CLIP	Built In Clip Wave Function
	CFACtor1	Built In CF-1 Wave Function
	CFACtor2	Built In CF-2 Wave Function
	SURGe	Built In Surge Wave Function
	DST<01 22>	Built In DST01 ~ DST22 Wave Function
Example	:SYST:ARB:EDIT:BUIL? TRI Returns the built in function of arbitrary edit	



Set →

### 3-7-3. :SYSTem:ARBitrary:EDIT:SURGe

→ Query

Description	Sets or queries the type and ACV and site parameter for built in Surge wave function	
Syntax	:SYSTem:ARBitrary:EDIT:SURGe <NR1>   SQU	
Query Syntax	SIN, <NR1>   MINimum   MAXimum, <NR1>   MINimum   MAXimum	
	:SYSTem:ARBitrary:EDIT:SURGe?	
Parameter	SQU   0	Square waveform type
<Type>	SIN   1	Sine waveform type
Parameter	<NR1>	ACV Ratio : 0 ~100(0 ~ 100%)
<ACV>	MINimum	Minimum ACV Ratio : 0 (0%)
	MAXimum	Maximum ACV Ratio : 100 (100%)
Parameter	<NR1>	Site Ratio : 0 ~100(0 ~ 100%)
<Site>	MINimum	Minimum Site Ratio : 0 (0%)
	MAXimum	Maximum Site Ratio : 100 (100%)
Return parameter	<Type>,<ACV>,<Site>	Returns the type and ACV and site parameter for built in Surge wave function
Example	:SYST:ARB:EDIT:SURG? SIN,+50,+25 Returns the type and ACV and site parameter for built in Surge wave function	

Set →

### 3-7-4. :SYSTem:ARBitrary:EDIT:STAIr

→ Query

Description	Sets or queries the stair parameter for built in stair wave function	
Syntax	:SYSTem:ARBitrary:EDIT:STAIr <NR1>	
Query Syntax	MINimum   MAXimu	
	:SYSTem:ARBitrary:EDIT:STAIr? [ MINimum   MAXimum ]?	
Parameter	<NR1>	stair : 1 ~ 100

	MINimum	Minimum stair : 1
	MAXimum	Maximum stair : 100
Return parameter	<NR1>	Returns the stair parameter for built in stair wave function

Example :SYST:ARB:EDIT:STA?  
+5  
Returns the stair parameter for built in stair wave function

Set →

### 3-7-5. :SYSTem:ARBitrary:EDIT:CFACtor2

→ Query

Description Sets or queries the crest factor parameter for built in CF-2 wave function

Syntax :SYSTem:ARBitrary:EDIT:CFACtor2 <NR2> |  
Query Syntax MINimum | MAXimum  
:SYSTem:ARBitrary:EDIT:CFACtor2? [ MINimum | MAXimum ]?

Parameter	<NR2>	crest factor : 1.5 ~ 2.0
	MINimum	Minimum crest factor : 1.5
	MAXimum	Maximum crest factor : 2.0
Return parameter	<NR2>	Returns the crest factor parameter for built in CF-2 wave function

Example :SYST:ARB:EDIT:CFAC2?  
+1.5000  
Returns the crest factor parameter for built in CF-2 wave function

Set →

### 3-7-6. :SYSTem:ARBitrary:EDIT:CFACtor1

→ Query

Description Sets or queries the crest factor parameter for built in CF-1 wave function

Syntax	:SYSTem:ARBitrary:EDIT:CFACtor1 <NR2>	
Query Syntax	MINimum   MAXimum	
	:SYSTem:ARBitrary:EDIT:CFACtor1? [ MINimum	
	MAXimum ]?	
Parameter	<NR2>	crest factor : 1.1 ~ 10.0
	MINimum	Minimum crest factor : 1.1
	MAXimum	Maximum crest factor : 10.0
Return parameter	<NR2>	Returns the crest factor parameter for built in CF-1 wave function
Example	:SYST:ARB:EDIT:CFAC1? +2.0000 Returns the crest factor parameter for built in CF-1 wave function	

Set →

→ Query

### 3-7-7. :SYSTem:ARBitrary:EDIT:CLIP

Description	Sets or queries the ratio parameter for built in clip wave function	
Syntax	:SYSTem:ARBitrary:EDIT:CLIP <NR2>   MINimum	
Query Syntax	MAXimum	
	:SYSTem:ARBitrary:EDIT:CLIP? [ MINimum	
	MAXimum ]?	
Parameter	<NR2>	clip ratio : 0.00 ~ 1.00
	MINimum	Minimum clip ratio : 0.00
	MAXimum	Maximum clip ratio : 1.00
Return parameter	<NR2>	Returns the ratio parameter for built in clip wave function
Example	:SYST:ARB:EDIT:CLIP? +0.5000 Returns the ratio parameter for built in clip wave function	

### 3-7-8. :SYSTem:ARBitrary:EDIT:STORE

Set →

Description	Saves the waveform data of built in into ARB1 ~ ARB16	
Syntax	:SYSTem:ARBitrary:EDIT:STORE <NR1>   ARB1   ARB2   ARB3   ARB4   ARB5   ARB6   ARB7   ARB8   ARB9   ARB10   ARB11   ARB12   ARB13   ARB14   ARB15   ARB16	
Parameter	ARB1   0	Saves the waveform data of built in into ARB1
	ARB2   1	Saves the waveform data of built in into ARB2
	ARB3   2	Saves the waveform data of built in into ARB3
	ARB4   3	Saves the waveform data of built in into ARB4
	ARB5   4	Saves the waveform data of built in into ARB5
	ARB6   5	Saves the waveform data of built in into ARB6
	ARB7   6	Saves the waveform data of built in into ARB7
	ARB8   7	Saves the waveform data of built in into ARB8
	ARB9   8	Saves the waveform data of built in into ARB9
	ARB10   9	Saves the waveform data of built in into ARB10
	ARB11   10	Saves the waveform data of built in into ARB11
	ARB12   11	Saves the waveform data of built in into ARB12
	ARB13   12	Saves the waveform data of built in into ARB13
	ARB14   13	Saves the waveform data of built in into ARB14
	ARB15   14	Saves the waveform data of built in into ARB15
	ARB16   15	Saves the waveform data of built in into ARB16

Example :SYST:ARB:EDIT:STOR ARB1  
Saves the waveform data of built in into ARB1

3-7-9. :SYSTem:ARBitrary:EDIT:TRlangle  

Description Sets or queries the symmetry parameter for built in triangle wave function

Syntax :SYSTem:ARBitrary:EDIT:TRlangle <NR1> |  
Query Syntax MINimum | MAXimum  
:SYSTem:ARBitrary:EDIT:TRlangle? [ MINimum | MAXimum ]?

Parameter	<NR1>	Symmetry : 0 ~ 100(0 ~ 100%)
	MINimum	Minimum Symmetry : 0 (0%)
	MAXimum	Maximum Symmetry : 100 (100%)

Return parameter	<NR1>	Returns the symmetry parameter for built in triangle wave function
------------------	-------	--

Example :SYST:ARB:EDIT:TRI?  
+50  
Returns the symmetry parameter for built in triangle wave function

3-7-10. :SYSTem:BEEPer:STATe  

Description Sets or queries the buzzer state on/off.

Syntax :SYSTem:BEEPer:STATe {<bool>|OFF|ON}

Query Syntax :SYSTem:BEEPer:STATe?

Parameter	OFF   0	Turns the buzzer off.
	ON   1	Turns the buzzer on.

Return parameter	<bool>	Returns the buzzer status.
------------------	--------	----------------------------

3-7-11.:SYSTem:COMMunicate:GPIB[:SELF]  
:ADDRess

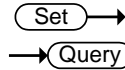

Description	Sets or queries the GPIB address.	
Note:	The setting will only be valid after the power has been cycled.	
Syntax	:SYSTem:COMMunicate:GPIB[:SELF]:ADDRess <NR1>	
Query Syntax	:SYSTem:COMMunicate:GPIB[:SELF]:ADDRess?	
Parameter	<NR1>	0~30
Return parameter	<NR1>	+0~+30
Example	SYST:COMM:GPIB:ADDR 15 Sets the GPIB address to 15.	

3-7-12.:SYSTem:COMMunicate:LAN:DHCP

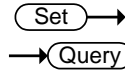

Description	Turns DHCP on/off. Queries the DHCP status.	
Note:	The setting will only be valid after the power has been cycled.	
Syntax	:SYSTem:COMMunicate:LAN:DHCP {<bool> OFF ON}	
Query Syntax	:SYSTem:COMMunicate:LAN:DHCP?	
Parameter	OFF   0	DHCP off
	ON   1	DHCP on
Return parameter	<bool>	Returns the DHCP status.

### 3-7-13. :SYSTem:COMMunicate:LAN:DNS

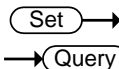

---

Description	Sets or queries the DNS address.
Note:	The setting will only be valid after the power has been cycled.
Syntax	:SYSTem:COMMunicate:LAN:DNS <string>
Query Syntax	:SYSTem:COMMunicate:LAN:DNS?
Parameter/Return	<string> DNS in string format ( "mask") Applicable ASCII characters: 20H to 7EH
Example	SYST:COMM:LAN:DNS "172.16.1.252" Sets the DNS to 172.16.1.252.

### 3-7-14. :SYSTem:COMMunicate:LAN:GATEway

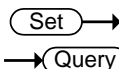

---

Description	Sets or queries the Gateway address.
Note:	The setting will only be valid after the power has been cycled.
Syntax	:SYSTem:COMMunicate:LAN:GATEway <string>
Query Syntax	:SYSTem:COMMunicate:LAN:GATEway?
Parameter/Return	<string> Gateway address in string format ( "address") Applicable ASCII characters: 20H to 7EH
Example	SYST:COMM:LAN:GATE "172.16.0.254" Sets the LAN gateway to 172.16.0.254.

3-7-15.:SYSTem:COMMunicate:LAN:IPADdress → Set →  
→ Query

Description	Sets or queries LAN IP address.
Note:	The setting will only be valid after the power has been cycled.
Syntax	:SYSTem:COMMunicate:LAN:IPADdress <string>
Query Syntax	:SYSTem:COMMunicate:LAN:IPADdress?
Parameter/Return	<string> LAN IP address in string format ("address") Applicable ASCII characters: 20H to 7EH
Example	SYST:COMM:LAN:IPAD "172.16.5.111" Sets the IP address to 172.16.5.111.

3-7-16.:SYSTem:COMMunicate:LAN:MAC → Query

Description	Returns the unit MAC address as a string. The MAC address cannot be changed.
Query Syntax	:SYSTem:COMMunicate:LAN:MAC?
Return parameter	<string> Returns the MAC address in the following format "FF-FF-FF-FF-FF-FF"
Example	SYST:COMM:LAN:MAC? 02-80-AD-20-31-B1 Returns the MAC address.

3-7-17.:SYSTem:COMMunicate:LAN:SMASk → Set →  
→ Query

Description	Sets or queries the LAN subnet mask.
Note:	The setting will only be valid after the power has been cycled.
Syntax	:SYSTem:COMMunicate:LAN:SMASk <string>
Query Syntax	:SYSTem:COMMunicate:LAN:SMASk?
Parameter/Return	<string> Subnet mask in string format ("mask") Applicable ASCII characters: 20H to 7EH
Example	SYST:COMM:LAN:SMASk "255.255.0.0" Sets the LAN mask to 255.255.0.0.



### 3-7-18. :SYSTem:COMMunicate:RLState

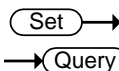

Description	Enables or disables local/remote state of the instrument.	
Syntax	:SYSTem:COMMunicate:RLState	
Query Syntax	{LOCAl   REMote   RWLock   LREMote}	
Parameter/Return parameter	LOCAL	All keys are valid. This instrument is controlled by the front panel controls.
	REMote	All keys are invalid, except for the [local] key and the ability to turn the output off.
	RWLock	All keys are invalid. The instrument can only be controlled remotely.
	LREMote	All keys are valid. This instrument is controlled by the front panel controls and remotely.
Example	:SYST:COMM:RLST LOCAL Sets the operating mode to local.	

### 3-7-19. :SYSTem:COMMunicate:SERial [:RECEive]:TRANsmit:BAUD

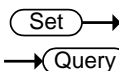

Description	Sets or queries the UART baud rate.	
Note:	The setting will only be valid after the power has been cycled.	
Syntax	:SYSTem:COMMunicate:SERial[:RECEive]:TRANsmit:BAUD <NR1>	
Query Syntax	:SYSTem:COMMunicate:SERial[:RECEive]:TRANsmit:BAUD?	
Parameter/Return	<NR1>	1200, 2400, 4800, 9600, 19200, 38400, 57600, 115200
Example	SYST:COMM:SER:TRAN:BAUD? >2400 Returns the baud rate settings.	

3-7-20.:SYSTem:COMMunicate:SERial  
[:RECeive]:TRANsmit:BITS

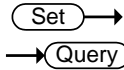

Description	Sets or queries the UART number of data bits.	
Note:	The setting will only be valid after the power has been cycled.	
Syntax	:SYSTem:COMMunicate:SERial[:RECeive]:TRANsmit	
Query Syntax	:BITS <NR1> :SYSTem:COMMunicate:SERial[:RECeive]:TRANsmit :BITS?	
Parameter	0	7 bits
	1	8 bits
Return parameter	+0	7 bits
	+1	8 bits
Example	SYST:COMM:SER:TRAN:BITS? >+1 Indicates that 8 data bits are used for the UART connection.	

3-7-21.:SYSTem:COMMunicate:SERial  
[:RECeive]:TRANsmit:PARity

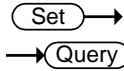

Description	Sets or queries the parity of the UART connection.	
Note:	The setting will only be valid after the power has been cycled.	
Syntax	:SYSTem:COMMunicate:SERial[:RECeive]:TRANsmit	
Query Syntax	:PARity {NONE ODD EVEN} :SYSTem:COMMunicate:SERial[:RECeive]:TRANsmit :PARity?	
Parameter	NONE	No parity
	ODD	Odd parity
	EVEN	Even parity
Return	+0	No parity

parameter	+1	Odd parity
	+2	Even parity
Example	SYST:COMM:SER:TRAN:PARity? >+0 Indicates that no parity is used for the UART connection.	

### 3-7-22. :SYSTem:COMMunicate:SERIAL [[:RECEive]:TRANsmit:SBITs (Set) → → (Query)

Description	Sets or queries the number of stop bits used for the UART connection.	
Note:	The setting will only be valid after the power has been cycled.	
Syntax	:SYSTem:COMMunicate:SERial[:RECEive]:TRANsmit	
Query Syntax	:SBITs <NR1> :SYSTem:COMMunicate:SERial[:RECEive]:TRANsmit :SBITs?	
Parameter	0	1 stop bit
	1	2 stop bits
Return parameter	+0	1 stop bit
	+1	2 stop bits
Example	SYST:COMM:SER:TRAN:SBITs? >+1 Indicates that one stop bit is used for the UART connection.	

### 3-7-23. :SYSTem:COMMunicate:TCPip:CONTRol → (Query)

Description	Queries the socket port number.	
Query Syntax	:SYSTem:COMMunicate:TCPip:CONTRol?	
Return parameter	<NR1>	0000 ~ 9999
Example	SYST:COMM:TCP:CONT? >2268 Returns the socket port number.	

### 3-7-24.:SYSTem:COMMunicate:USB:FRONT:STATE

→ Query

Description	Queries the front panel USB-A port state.	
Query Syntax	:SYSTem:COMMunicate:USB:FRONT:STATE?	
Return parameter	+0	<NR1>Absent
	+1	<NR1>Mass Storage

### 3-7-25.:SYSTem:COMMunicate:USB:REAR:STATE

→ Query

Description	Queries the rear panel USB-B port state.	
Query Syntax	:SYSTem:COMMunicate:USB:REAR:STATE?	
Return parameter	+0	<NR1>Absent
	+1	<NR1>Connected to the PC

Set →

### 3-7-26.:SYSTem:CONFIgure[:MODE]

→ Query

Description	Sets or queries the test mode for the power supply.	
Syntax	:SYSTem:CONFIgure[:MODE] {<NR1> CONTInuous SEQuence SIMulation} (SEQ is available for AC+DC-INT, AC-INT, DC-INT Modes, whilst SIM is available for AC+DC-INT Mode.)	
Query Syntax	:SYSTem:CONFIgure[:MODE]?	
Parameter	0   CONTInuous	Continuous mode (normal operating mode)
	1   SEQuence	Sequence mode
	2   SIMulation	Simulation mode
Return parameter	CONT	Continuous mode (normal operating mode)
	SEQ	Sequence mode
	SIM	Simulation mode

### 3-7-27. :SYSTem:CONFIgure:EXTIo[:STATe]

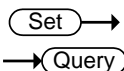

Description	Sets or queries the external control state on/off.	
Syntax	:SYSTem:CONFIgure:EXTIo[:STATe]	
Query Syntax	{<bool> OFF ON}	
	:SYSTem:CONFIgure:EXTIo[:STATe]?	
Parameter	OFF   0	Turns the external control off.
	ON   1	Turns the external control on.
Return parameter	<bool>	Returns the external control status.

### 3-7-28. :SYSTem:CONFIgure:TRIGger:OUTPut: SOURce

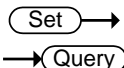

Description	Sets or queries the trigger output source.	
Syntax	:SYSTem:CONFIgure:TRIGger:OUTPut:SOURce <NR1>   NONE   ZERO-cross   OUTPut-off	
Query Syntax	:SYSTem:CONFIgure:TRIGger:OUTPut: SOURce?	
Parameter	NONE   0	No pulse output
	ZERO-cross   1	Outputs pulse at zero cross (0°)
	OUTPut-off   2	Outputs pulse when output is off
Return parameter	None	No pulse output
	Zero-Cross	Outputs pulse at zero cross (0°)
	Output-OFF	Outputs pulse when output is off

### 3-7-29. :SYSTem:CONFIgure:TRIGger:OUTPut: WIDTh

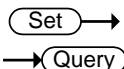

Description	Sets or queries the trigger signal output width. (Not available for DC-INT, AC+DC-EXT, AC-EXT.)	
Syntax	:SYSTem:CONFIgure:TRIGger:OUTPut:WIDTh	
Query Syntax	<NR2>   MINimum   MAXimum	
	:SYSTem:CONFIgure:TRIGger:OUTPut:WIDTh?	
Parameter	<NR2>	Trigger signal output width.

	MINimum	Minimum settable trigger signal output width.
	MAXimum	Maximum settable trigger signal output width.
Return parameter	<NR2>	Returns the trigger signal output width.

### 3-7-30.:SYSTem:ERRor → Query

**Description** Queries the error queue. The last error message is returned. A maximum of 32 errors are stored in the error queue.

**Query Syntax** :SYSTem:ERRor?

**Return parameter** <string> Returns an error code followed by an error message as a single string.

**Example** SYSTem:ERRor?  
-100, "Command error"

### 3-7-31.:SYSTem:ERRor:ENABle Set →

**Description** Clears the Error Queue and enables all error messages to be placed in the System Error Queue.

**Syntax** :SYSTem:ERRor:ENABle

### 3-7-32.:SYSTem:HOLD:STATe Set → → Query

**Description** Sets or queries the freeze hold state on/off.

**Syntax** :SYSTem:HOLD:STATe {<bool>|OFF|ON}

**Query Syntax** :SYSTem:HOLD:STATe?

**Parameter** OFF | 0 Turns the freeze hold off.

ON | 1 Turns the freeze hold on.

**Return parameter** <bool> Returns the freeze hold status.

### 3-7-33. :SYSTem:IPKHold:TIME

Set →  
→ Query

Description	Sets or queries the lpeak hold time for peak current measurement when output on.	
Syntax	:SYSTem:IPKhold:TIME {<NR1>}	
Query Syntax	:SYSTem:IPKhold:TIME?	
Parameter	<NR1>	1~60000
Return parameter	<NR1>	+1~+60000
Example	:SYST:IPKH:TIME 10 Sets the lpeak hold time 10ms to measure when output on.	

### 3-7-34. :SYSTem:KLOCK

Set →  
→ Query

Description	Enables or disables the front panel key lock.	
Syntax	:SYSTem:KLOCK {<bool> OFF ON}	
Query Syntax	:SYSTem:KLOCK?	
Parameter	OFF   0	Panel keys unlocked
	ON   1	Panel keys locked
Return parameter	<bool>	Returns the key lock status.

### 3-7-35. :SYSTem:REBoot

Set →

Description	Reboots the ASR system.	
Syntax	:SYSTem:REBoot	

### 3-7-36. :SYSTem:SCPI:DATA CLear

Set →

Description	Clear recorded SCPI data.	
Syntax	:SYSTem:SCPI:DATA CLear	

### 3-7-37.:SYSTem:SCPI:DATA

→ Query

---

Description	Query recorded SCPI data.
Query Syntax	:SYSTem:SCPI:DATA? {RS232   USB   GPIB   LAN}

### 3-7-38.:SYSTem:SCPI:DATA? Error

→ Query

---

Description	Queries SCPI command that caused SCPI error.
Query Syntax	:SYSTem:SCPI:DATA? Error

### 3-7-39.:SYSTem:SLEW:MODE

Set →

→ Query

---

Description	Sets or queries slew mode setting.	
Syntax	:SYSTem:SLEW:MODE {<bool> TIME SLOPe}	
Query Syntax	:SYSTem:SLEW:MODE?	
Parameter	TIME   0	Sets the Time mode.
	SLOPe   1	Sets the Slope mode.
Return parameter	<bool>	Returns the slew mode setting.
Example	:SYST:SLEW:MODE TIME Sets the Time mode for slew mode.	

Set →

→ Query

### 3-7-40.:SYSTem:VUNit

---

Description	Sets or queries V unit setting.	
Syntax	:SYSTem:VUNit {<NR1> RMS P-P}	
Query Syntax	:SYSTem:VUNit?	
Parameter	RMS   0	Sets the RMS.
	P-P   1	Sets the P-P.
Return parameter	+0	The Unit of Voltage Setting is Vrms.
	+1	The Unit of Voltage Setting is Vpp.
Example	:SYST:VUN RMS Sets the RMS for V unit.	



### 3-8. Source Commands

#### 3-8-1. [:SOURce]:CURRent:LIMit:PEAK:HIGH

Description	Sets or queries the lpk-High Limit parameter for the continuous operation mode.	
Syntax	[:SOURce]:CURRent:LIMit:PEAK:HIGH {<NR2> MINimum MAXimum}	
Query Syntax	[:SOURce]:CURRent:LIMit:PEAK:HIGH?	
Parameter	<NR2>	lpk-High Limit in Arms.
	MINimum	Minimum settable peak current high limit
	MAXimum	Maximum settable peak current high limit
Return parameter	<NR2>	Returns the lpk-High Limit value
Example	CURR:LIM:PEAK:HIGH? +16.8000 Returns the peak current high limit as 16.8A.	

#### 3-8-2. [:SOURce]:CURRent:LIMit:PEAK:LOW

Description	Sets or queries the lpk-Low Limit parameter for the continuous operation mode.	
Syntax	[:SOURce]:CURRent:LIMit:PEAK:LOW {<NR2> MINimum MAXimum}	
Query Syntax	[:SOURce]:CURRent:LIMit:PEAK:LOW?	
Parameter	<NR2>	lpk-Low Limit in Arms.
	MINimum	Minimum settable peak current low limit
	MAXimum	Maximum settable peak current low limit
Return parameter	<NR2>	Returns the lpk-Low Limit value

Example :CURR:LIM:PEAK:LOW?  
 -14.8000  
 Returns the peak current low limit as -14.8A.

3-8-3. [:SOURce]:CURRent:LIMit:RMS  
 [:AMPLitude]

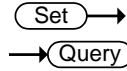

Description	Sets or queries the Irms parameter for the continuous operation mode.	
Syntax	[:SOURce]:CURRent:LIMit:RMS[:AMPLitude] {<NR2> MINimum MAXimum}	
Query Syntax	[:SOURce]:CURRent:LIMit:RMS[:AMPLitude]?	
Parameter	<NR2>	Irms in A.
	MINimum	Minimum settable current
	MAXimum	Maximum settable current
Return parameter	<NR2>	Returns the Irms.
Example	:CURR:LIM:RMS? +5.2500 Returns the Irms setting.	

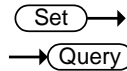

3-8-4. [:SOURce]:CURRent:LIMit:PEAK:MODE

Description	Sets or queries Ipk limit enabled or disabled.	
Syntax	[:SOURce]:CURRent:LIMit:PEAK:MODE {<bool> OFF ON}	
Query Syntax	[:SOURce]:CURRent:LIMit:PEAK:MODE?	
Parameter	OFF 0	Ipk limit off
	ON 1	Ipk limit on
Return parameter	+0	Ipk limit off
	+1	Ipk limit on
Example	:CURR:LIM:PEAK:MODE ON Sets Ipk limit enabled.	

### 3-8-5. [:SOURce]:CURRent:LIMit:RMS:MODE

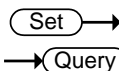

Description	Sets or queries IRMS OC-Fold enable.	
Syntax	[:SOURce]:CURRent:LIMit:RMS:MODE {<bool> OFF ON}	
Query Syntax	[:SOURce]:CURRent:LIMit:RMS:MODE?	
Parameter	OFF 0	IRMS limit off
	ON 1	IRMS limit on
Return parameter	+0	IRMS limit off
	+1	IRMS limit on
Example	:CURR:LIM:RMS:MODE ON Sets IRMS limit enabled.	

### 3-8-6. [:SOURce]:FREQUency:LIMit:HIGH

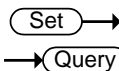

Description	Sets or queries the frequency upper limit range. (Only AC+DC-INT or AC-INT or AC+DC-ADD or AC-ADD Active)	
Syntax	[:SOURce]:FREQUency:LIMit:HIGH {<NR2> MINimum MAXimum}	
Query Syntax	[:SOURce]:FREQUency:LIMit:HIGH? [INimum MAXimum]	
Parameter	<NR2>	Frequency in Hz.
	MINimum	Minimum settable frequency
	MAXimum	Maximum settable frequency
Return parameter	<NR2>	Returns the frequency limit
Example	FREQ:LIM:HIGH? +60.5000 Returns the frequency upper limit.	

### 3-8-7. [:SOURce]:FREQUency:LIMit:LOW

Set →  
→ Query

Description	Sets or queries the frequency lower limit range. (Only AC+DC-INT or AC-INT or AC+DC-ADD or AC-ADD Active)	
Syntax	[:SOURce]:FREQUency:LIMit:LOW {<NR2> MINimum MAXimum}	
Query Syntax	[:SOURce]:FREQUency:LIMit:LOW?	
Parameter	<NR2>	Frequency in Hz.
	MINimum	Minimum settable frequency
	MAXimum	Maximum settable frequency
Return parameter	<NR2>	Returns the frequency limit
Example	FREQ:LIM:LOW? +60.5000 Returns the frequency lower limit.	

### 3-8-8. [:SOURce]:FREQUency[:IMMEDIATE]

Set →  
→ Query

Description	Sets or queries the frequency for the immediate trigger. (Only AC+DC-INT or AC-INT or AC+DC-ADD or AC-ADD Active)	
Syntax	[:SOURce]:FREQUency[:IMMEDIATE] {<NR2>(HZ) MINimum MAXimum}	
Query Syntax	[:SOURce]:FREQUency[:IMMEDIATE]?	
Parameter	<NR2>	Frequency setting in Hz.
	MINimum	Minimum frequency.
	MAXimum	Maximum frequency.
Return parameter	<NR2>	Returns the frequency.
Example	:FREQ 60.00 Sets the frequency of 60Hz.	

3-8-9. [:SOURce]:FUNcTion[:SHAPe]  
[:IMMEDIATE]

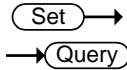

Description	Sets or queries the waveforms of power supply. (Not available for AC+DC-EXT or AC-EXT)	
Syntax	[:SOURce]:FUNcTion[:SHAPe][:IMMEDIATE] {<NR1> ARB1 ARB2 ARB3 ARB4 ARB5 ARB6 ARB7 ARB8 ARB9 ARB10 ARB11 ARB12 ARB13 ARB14 ARB15 ARB16 SIN SQU TRI}	
Query Syntax	[:SOURce]:FUNcTion[:SHAPe][:IMMEDIATE]?	
Parameter / Return parameter	<NR1>	From 0 – 18, which represent different waveforms, respectively. Return parameter is <string>.
	ARB1	Arbitrary wave 1
	ARB2	Arbitrary wave 2
	ARB3	Arbitrary wave 3
	ARB4	Arbitrary wave 4
	ARB5	Arbitrary wave 5
	ARB6	Arbitrary wave 6
	ARB7	Arbitrary wave 7
	ARB8	Arbitrary wave 8
	ARB9	Arbitrary wave 9
	ARB10	Arbitrary wave 10
	ARB11	Arbitrary wave 11
	ARB12	Arbitrary wave 12
	ARB13	Arbitrary wave 13
	ARB14	Arbitrary wave 14
	ARB15	Arbitrary wave 15
	ARB16	Arbitrary wave 16
SIN	Sin wave	
SQU	Square wave	
TRI	Triangle wave	
Example	:SOUR:FUNC:SHAP:IMM? TRI Returns the waveform as Triangle wave.	

### 3-8-10.[:SOURce]:FUNCTION:THD:FORMat

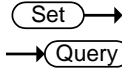

Description	Sets or queries the THD format.	
Syntax	[:SOURce]:FUNCTION:THD:FORMat {<bool> IEC CSA}	
Query Syntax	[:SOURce]:FUNCTION:THD:FORMat?	
Parameter	IEC 0	IEC THD format
	CSA 1	CSA THD format
Return parameter	IEC	IEC THD format
	CSA	CSA THD format
Example	:SOUR:FUNC:THD:FORM? IEC Returns the THD format as IEC.	

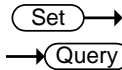

### 3-8-11.[:SOURce]:MODE

Description	Sets or queries the output mode of power supply.	
Syntax	[:SOURce]:MODE {<NR1> ACDC-INT AC-INT DC-INT ACDC-EXT AC-EXT ACDC-ADD AC-ADD ACDC-SYNC AC-SYNC}	
Query Syntax	[:SOURce]:MODE?	
Parameter / Return parameter	<NR1>	From 0 – 8, which represent different output modes, respectively. Return parameter is <string>.
	ACDC-INT	AC+DC-INT
	AC-INT	AC-INT
	DC-INT	DC-INT
	ACDC-EXT	AC+DC-EXT
	AC-EXT	AC-EXT
	ACDC-ADD	AC+DC-ADD
	AC-ADD	AC-ADD
	ACDC-SYNC	AC+DC-SYNC
	AC-SYNC	AC-SYNC

Example        MODE?  
                  AC+DC-INT  
                  Returns the output mode as AC+DC-INT.

Set →

3-8-12. [:SOURCE]:PHASe:STARt:STATe

→ Query

Description    Sets or queries state of start phase. (Not available for DC-INT, AC+DC-EXT and AC-EXT)

Syntax         [:SOURCE]:PHASe:STARt:STATe  
                  {<bool>|FREE|FIXED}

Query Syntax   [:SOURCE]:PHASe:STARt:STATe?

Parameter	FREE   0	Start phase Free
	FIXED   1	Start phase Fixed

Return parameter	FREE	Start phase Free
	FIXED	Start phase Fixed

Example        :PHAS:STAR:STAT?  
                  FREE  
                  Returns the state of start phase as Free.

Set →

3-8-13. [:SOURCE]:PHASe:STOP:STATe

→ Query

Description    Sets or queries state of stop phase. (Not available for DC-INT, AC+DC-EXT and AC-EXT)

Syntax         [:SOURCE]:PHASe:STOP:STATe  
                  {<bool>|FREE|FIXED}

Query Syntax   [:SOURCE]:PHASe:STOP:STATe?

Parameter	FREE   0	Start phase Free
	FIXED   1	Start phase Fixed

Return parameter	FREE	Start phase Free
	FIXED	Start phase Fixed

Example        :PHAS:STOP:STAT?  
                  FIXED  
                  Returns the state of stop phase as Fixed.

### 3-8-14. [:SOURce]:PHASe:STARt[:IMMediate]

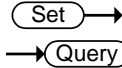

Description	Sets or queries the start phase. (Not available for DC-INT, AC+DC-EXT and AC-EXT)	
Syntax	[:SOURce]:PHASe:STARt[:IMMediate] {<NR2> MINimum MAXimum}	
Query Syntax	[:SOURce]:PHASe:STARt[:IMMediate]?	
Parameter	<NR2>	Start phase value
	MINimum	0.0
	MAXimum	359.9
Return parameter	<NR2>	Returns the start phase value.
Example	:PHAS:STAR 0 Sets the starting phase to 0.	

### 3-8-15. [:SOURce]:PHASe:STOP[:IMMediate]

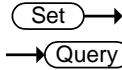

Description	Sets or queries the off phase of the waveform. (Not available for DC-INT, AC+DC-EXT and AC-EXT)	
Note:	Sets the off phase of the waveform after the output has been turned off.	
Syntax	[:SOURce]:PHASe:STOP[:IMMediate] {<NR2> MINimum MAXimum}	
Query Syntax	[:SOURce]:PHASe:STOP[:IMMediate]?	
Parameter	<NR2>	Stop phase value
	MINimum	0.0
	MAXimum	359.9
Return parameter	<NR2>	Returns the stop phase value.
Example	:PHAS:STOP 60 Sets the stop phase to 60.	



### 3-8-16. [:SOURce]:PHASe:SYNC[:IMMEDIATE]

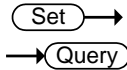

Description	Sets or queries the sync phase of the waveform. (Available for AC+DC-Sync and AC-Sync)	
Syntax	[:SOURce]:PHASe:SYNC[:IMMEDIATE] {<NR2>   MINimum   MAXimum}	
Query Syntax	[:SOURce]:PHASe:SYNC[:IMMEDIATE]?	
Parameter	<NR2> MINimum MAXimum	Sync phase value 0 359.9
Return parameter	<NR2>	Returns the sync phase value.
Example	:PHAS:SYNC 60 Sets the sync phase to 60.	

### 3-8-17. [:SOURce]:READ



Description	Returns the measurement readouts.	
Query Syntax	[:SOURce]:READ?	
Return parameter	<Vrms>,<Vavg>,<Vmax>,<Vmin>,<Irms>,<lavg>,<lmax>,<lmin>,<lpkH>,<P>,<S>,<Q>,<PF>,<CF>,<THDv>,<THDi>,<Freq>	<THDv>,<THDi> returns values in AC-INT mode only, whereas returns Invalid in other modes. <S>,<Q>,<PF>,<CF> returns Invalid in DC-INT mode. <Freq> returns values in AC+DC-Sync and AC-Sync modes only, whereas returns Invalid in other modes.
Example	:READ? >+0.3204,+0.0306,+0.1879,-0.5809,+0.0121, -0.0007, +0.0030, -0.0060, -0.0201, +0.0013, +0.0039, +0.0037, +0.3400, +1.1500, Invalid, Invalid, Invalid	

### 3-8-18. [:SOURce]:VOLTage:RANGe

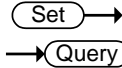

Description	Sets or queries the voltage range.	
Syntax	[:SOURce]:VOLTage:RANGe {<NR1> 100 200 AUTO}	
Query Syntax	[:SOURce]:VOLTage:RANGe?	
Parameter / Return parameter	<NR1>	From 0 – 2, which represent different voltage ranges, respectively. Return parameter is 100,200 or AUTO.
	100	100V
	200	200V
	AUTO	AUTO (Only AC+DC-INT or AC-INT or DC-INT or AC+DC-sync or AC-sync Active)
Example	:SOUR:VOLT:RANG? 200V Returns the voltage range as 200V.	

### 3-8-19. [:SOURce]:VOLTage:LIMit:RMS

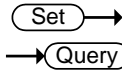

Description	Sets or queries the voltage limit for the continuous operation mode. (Only AC-INT or AC-ADD or AC-Sync Active)	
Syntax	[:SOURce]:VOLTage:LIMit:RMS {<NR2> MINimum MAXimum}	
Query Syntax	[:SOURce]:VOLTage:LIMit:RMS?	
Parameter	<NR2>	Vrms.
	MINimum	Minimum voltage limit
	MAXimum	Maximum voltage limit
Return parameter	<NR2>	Returns the voltage limit.
Example	VOLT:LIM:RMS? +350.0000 Returns the Vrms limit.	

### 3-8-20. [:SOURce]:VOLTage:LIMit:HIGH

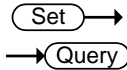

Description	Sets or queries the voltage high limit. (Only AC+DC-INT or DC-INT or AC+DC-ADD or AC+DC-Sync Active)	
Syntax	[:SOURce]:VOLTage:LIMit:HIGH {<NR2> MINimum MAXimum}	
Query Syntax	[:SOURce]:VOLTage:LIMit:HIGH?	
Parameter	<NR2>	Voltage high limit
	MINimum	Minimum voltage high limit
	MAXimum	Maximum voltage high limit
Return parameter	<NR2>	Returns the voltage high limit.
Example	VOLT:LIM:HIGH? +500.0000 Returns the voltage high limit.	

### 3-8-21. [:SOURce]:VOLTage:LIMit:LOW

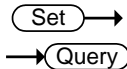

Description	Sets or queries the voltage low limit. (Only AC+DC-INT or DC-INT or AC+DC-ADD or AC+DC-Sync Active)	
Syntax	[:SOURce]:VOLTage:LIMit:LOW {<NR2> MINimum MAXimum}	
Query Syntax	[:SOURce]:VOLTage:LIMit:LOW?	
Parameter	<NR2>	Voltage low limit
	MINimum	Minimum voltage low limit
	MAXimum	Maximum voltage low limit
Return parameter	<NR2>	Returns the voltage low limit.
Example	VOLT:LIM:LOW? -250.0000 Returns the voltage low limit.	

### 3-8-22. [:SOURce]:VOLTage:LIMit:PEAK

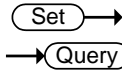

Description	Sets or Queries the Value of Vpp in Specific Mode(AC-INT or AC-ADD or AC-Sync) and Wave Shape(TRI or ARB) and V Unit(p-p)	
Syntax	[:SOURce]:VOLTage:LIMit:PEAK <NR2>   MINimum   MAXimum	
Query Syntax	[:SOURce]:VOLTage:LIMit:PEAK?	
Parameter	<NR2> MINimum MAXimum	Vp-p Minimum voltage Maximum voltage
Return parameter	<NR2>	Returns the voltage.
Example	VOLT:LIM:PEAK? +350.0000 Returns the Vp-p limit.	

### 3-8-23. [:SOURce]:VOLTage[:LEVel][:IMMEDIATE] [:AMPLitude]

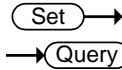

Description	Sets or queries the RMS voltage for the continuous operation mode. (Not available for DC-INT, AC+DC-EXT and AC-EXT)	
Syntax	[:SOURce]:VOLTage[:LEVel][:IMMEDIATE][:AMPLitude] {<NR2>(V) MINimum MAXimum}	
Query Syntax	[:SOURce]:VOLTage[:LEVel][:IMMEDIATE][:AMPLitude]?	
Parameter	<NR2> MINimum MAXimum	Vrms. Minimum voltage Maximum voltage
Return parameter	<NR2>	Returns the voltage.
Example	:VOLT 150.0 Sets the voltage to 150.0 ACV.	

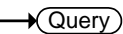
3-8-24. [:SOURce]:VOLTage[:LEVel][:IMMediate]: OFFSet 



Description	Sets or queries the voltage offset value. (Only AC+DC-INT or DC-INT or AC+DC-ADD or AC+DC-Sync Active)	
Syntax	[:SOURce]:VOLTage[:LEVel][:IMMediate]:OFFSet {<NR2>(V) MINimum MAXimum}	
Query Syntax	[:SOURce]:VOLTage[:LEVel][:IMMediate]:OFFSet?	
Parameter	<NR2>	Voltage offset value
	MINimum	Minimum voltage offset value
	MAXimum	Maximum voltage offset value
Return parameter	<NR2>	Returns the voltage offset value.
Example	:VOLT:OFFS? +150.0000 Returns the voltage offset value as 150.0.	

## 3-9.Sequence Commands

### 3-9-1. [:SOURce]:SEQuence:CPARAmeter

Set →

Description	Sets the common parameters for the Sequence mode. Please see the user manual for a full description of each parameter.	
Syntax	[:SOURce]:SEQuence:CPARAmeter {<NR2>,<NR2>,<bool> OFF ON,<NR2>,<bool> OFF ON,<NR1> CONTInue END HOLD,<NR1>,<bool> OFF ON,<NR1>,<bool> OFF ON,<NR1>,<bool> OFF ON,<NR1>,<bool> OFF ON,<NR1>,<bool> OFF ON,<NR1>,<bool> OFF ON}	
Query Syntax	[:SOURce]:SEQuence:CPARAmeter?	
Parameter	<NR2>	Step Time
	<NR2>	On phase
	<bool> OFF ON FREE FIXED	On phase off (free)(1) / on (fixed)(0)
	<NR2>	Off phase
	<bool> OFF ON FREE FIXED	Off phase off (free) / on (fixed)
	<NR1> CONTInue END HOLD	Term settings: Continue(1)/End(2)/Hold(3)
	<NR1>	Jump step number (0 ~ 999)
	<bool> OFF ON	Jump on(1)/off(0)
	<NR1>	Jump Cnt (0~ 9999)
	<NR1>	Sync Code: LL(0) / LH(1) / HL(2) / HH(3)
	<NR1>	Branch1 (0 ~ 999)
	<bool> OFF ON	Branch1 on(1)/off(0)
	<NR1>	Branch2 (0 ~ 999)
	<bool> OFF ON	Branch2 on(1)/off(0)
	<bool> OFF ON	This parameter is w/o function.



note

Set step 0 to "0" for the jump step number, jump count, branch 1 (step), and branch 2 (step). Anything other than 0 will result in an error.

Return parameter	<p>&lt;NR2&gt;,&lt;NR2&gt;,&lt;bool&gt;,&lt;NR2&gt;,&lt;bool&gt;,&lt;NR1&gt;,&lt;NR1&gt;,&lt;bool&gt;,&lt;NR1&gt;,&lt;NR1&gt;,&lt;bool&gt;,&lt;NR1&gt;,&lt;bool&gt;,&lt;bool&gt;</p> <p>Returns the common parameters in the following order: Step time, on phase, on phase on/off, off phase, off phase on/off, term settings, jump step number, jump on/off, jump count, code on/off, branch1, branch1 on/off, branch2, branch2 on/off, trig out on/off,+0.</p> <p>Time:Fixed to 4 digits after the decimal point. Phase: Fixed to 1 digit after the decimal point.</p>
Example1	:SEQ:CPAR 1,0,10,1,HOLD,10,1,0,1,0,0,0,1,0
Example2	:SEQ:CPAR? +0.1000,+0,+0,+0,+0,CONT,+1,+1,+1,+0,+0,+0,+0,+0,+0

### 3-9-2. [:SOURce]:SEQuence:CSTep →(Query)

Description	Returns the currently running step number.
Query Syntax	[:SOURce]:SEQuence:CSTep?
Return parameter	<NR1> Current step number
Example	:SEQ:CSTep? +1

### 3-9-3. [:SOURce]:SEQuence:SPARAmeter →(Query)

Description	<p>Sets or queries the parameters for a specified step.</p> <p>Depending on the output mode, some parameters may not be displayed on the screen, but those parameters cannot be omitted.</p>
Syntax	[:SOURce]:SEQuence:SPARAmeter {<NR2>,<NR1> CONST KEEP SWEep,<NR2>,<NR1> CONST KEEP SWEep,<NR2>,<NR1> CONST KEEP SWEep,SIN,<NR1>}
Query Syntax	[:SOURce]:SEQuence:SPARAmeter?
Parameter	<NR2> ACV setting

<NR1> CONST	ACV mode: Constant(0)
KEEP SWEep	Keep(1)   Sweep(2)
<NR2>	DCV setting
<NR1> CONST	DCV mode: Constant(0)
KEEP SWEep	Keep(1)   Sweep(2)
<NR2>	Frequency
<NR1> CONST	Frequency mode: Constant(0)
KEEP SWEep	Keep(1)   Sweep(2)
Waveform	ARB1 ARB2 ARB3 ARB4 ARB5  ARB6 ARB7 ARB8 ARB9 ARB 10 ARB11 ARB12 ARB13 ARB1 4 ARB15 ARB16 SIN SQU TRI
<NR1>	Phase angle. Fixed to 0.

Return parameter	<NR2>,<NR1> CONST KEEP SWEep,<NR2>,<NR1> CONST KEEP SWEep,ARB1 ARB2 ARB3 ARB4 ARB5 ARB6 ARB7 ARB8 ARB9 ARB10 ARB11 ARB12 ARB13 ARB14 ARB15 ARB16 SIN SQU TRI,<NR1> Returns the step parameters in the following order: ACV, ACV mode, DCV, DCV mode, frequency, frequency mode, wave, phase. ACV,DCV: Fixed to 1 digit after the decimal point, Frequency: Fixed to 2 digits after the decimal point
------------------	--

Example :SEQ:SPAR?  
+0.0,CONST,+0.0,CONST,+50.00,CONST,SIN,0

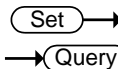

### 3-9-4. [:SOURce]:SEQuence:STEP

Description	Sets or queries the current step number.
Syntax	[:SOURce]:SEQuence:STEP {<NR1> MINimum MAXimum}
Query Syntax	[:SOURce]:SEQuence:STEP?
Parameter	<NR1> Step number MINimum Minimum step number MAXimum Maximum step number
Return parameter	<NR1> Returns the step number.

Example :SEQ:STEP 1  
Sets the step number to 1.



### 3-9-5. [:SOURce]:SEQuence:CONDition

→(Query)

Description	Returns the sequence status.(Only Sequence Mode Active)		
Syntax	[:SOURce]:SEQuence:CONDition?		
Return parameter	<NR1>	Current sequence status	0 (Idle mode) 1 (Run mode) 2 (Hold mode)
Example	:SEQ:COND? 1		

### 3-9-6. :TRIGger:SEQuence:SElected:EXECute

(Set)→

Description	Sets to execute actions for sequence mode		
Syntax	:TRIGger:SEQuence:SElected:EXECute {STOP STARt HOLD BRAN1 BRAN2}		
Parameter	STOP	Stops sequence execution	
	STARt	Starts sequence execution	
	HOLD	Holds sequence execution	
	BRAN1	Jumps to Branch 1 execution	
	BRAN2	Jumps to Branch 2 execution	
Example	TRIG:SEQ:SEL:EXEC STAR Starts sequence execution.		

## 3-10. Simulate Commands

### 3-10-1. [:SOURce]:SIMulation:CONDition

→ Query

Description	Returns the simulation status. (Only Simulation Mode Active)		
Query Syntax	[:SOURce]:SIMulation:CONDition?		
Return parameter	<NR1>	Current simulation status	0 (Idle mode) 1 (Run mode) 2 (Hold mode)
Example	SIM:COND? 1		

### 3-10-2. [:SOURce]:SIMulation:ABNormal:CODE

Set →

→ Query

Description	Sets the external trigger output for the abnormal step parameter. This option is only applicable when in the Simulation mode.		
Syntax	[:SOURce]:SIMulation:ABNormal:CODE {<NR1> MINimum MAXimum}		
Query Syntax	[:SOURce]:SIMulation:ABNormal:CODE?		
Parameter	<NR1>	0=LL, 1=LH, 2=HL, 3=HH.	
	MINimum	0 (LL)	
	MAXimum	3 (HH)	
Return parameter	<NR1>	Returns the external trigger output.	
Example	SIM:ABN:CODE 1		

### 3-10-3. [:SOURce]:SIMulation:ABNormal: FREQUENCY

Set →  
→ Query

Description	Sets or queries the frequency of the abnormal step of the simulation mode.	
Syntax	[:SOURce]:SIMulation:ABNormal:FREQUENCY {<NR2> MINimum MAXimum}	
Query Syntax	[:SOURce]:SIMulation:ABNormal:FREQUENCY?	
Parameter	<NR2> MINimum MAXimum	Frequency of abnormal step Minimum frequency Maximum frequency
Return parameter	<NR2>	Returns the frequency of abnormal step. Fixed to 2 digits after the decimal point.
Example	:SIM:ABN:FREQ 55 Sets the frequency to 55Hz.	

### 3-10-4. [:SOURce]:SIMulation:ABNormal:PHASe: START:ENABLE

Set →  
→ Query

Description	Enables/Disables (Fixed/Free) the ON Phs parameter of the abnormal step for the Simulation mode.	
Syntax	[:SOURce]:SIMulation:ABNormal:PHASe:START :ENABLE {<bool> OFF ON FREE FIXED}	
Query Syntax	[:SOURce]:SIMulation:ABNormal:PHASe:START :ENABLE?	
Parameter	OFF   0   FREE ON   1   FIXED	Disabled Enabled
Return parameter	+0 +1	Disabled Enabled
Example	:SIM:ABN:PHAS:STAR:ENAB 1 Enable the ON Phs.	

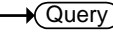
3-10-5. [:SOURce]:SIMulation:ABNormal:PHASe:  →  
 START[:IMMEDIATE] 

Description	Sets or queries the ON Phs parameter of the abnormal step for the Simulation mode.	
Syntax	[:SOURce]:SIMulation:ABNormal:PHASe:START[:IMMEDIATE] {<NR2> MINimum MAXimum}	
Query Syntax	[:SOURce]:SIMulation:ABNormal:PHASe:START[:IMMEDIATE]?	
Parameter	<NR2>	ON Phs (start phase)
	MINimum	0.0
	MAXimum	359.9
Return parameter	<NR2>	Returns the ON Phs (start phase). Fixed to 1 digit after the decimal point.
Example	:SIM:ABN:PHAS:STAR 0 Sets ON Phs to 0.	

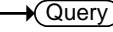
3-10-6. [:SOURce]:SIMulation:ABNormal:PHASe:  →  
 STOP:ENABLE 

Description	Enables/Disables (Fixed/Free) the OFF Phs parameter of the abnormal step for the Simulation mode.	
Syntax	[:SOURce]:SIMulation:ABNormal:PHASe:STOP:ENABLE {<bool> OFF ON FREE FIXED }	
Query Syntax	[:SOURce]:SIMulation:ABNormal:PHASe:STOP:ENABLE?	
Parameter	OFF   0   FREE	Disabled
	ON   1   FIXED	Enabled
Return parameter	+0	Disabled
	+1	Enabled
Example	:SIM:ABN:PHAS:STOP:ENAB 1 Enable the OFF Phs.	

3-10-7. [:SOURce]:SIMulation:ABNormal:PHASe: STOP[:IMMEDIATE] (Set) →  
→ (Query)

Description	Sets or queries the OFF Phs parameter of the abnormal step for the Simulation mode.	
Note:	Sets the off phase of the waveform after the output has been turned off.	
Syntax	[:SOURce]:SIMulation:ABNormal:PHASe:STOP[:IMMEDIATE] {<NR2> MINimum MAXimum}	
Query Syntax	[:SOURce]:SIMulation:ABNormal:PHASe:STOP[:IMMEDIATE]?	
Parameter	<NR2> MINimum MAXimum	OFF Phs (Stop phase) 0.0 359.9
Return parameter	<NR2>	Returns the OFF Phs (Stop phase). Fixed to 1 digit after the decimal point.
Example	:SIM:ABN:PHAS:STOP 0 Sets OFF Phs to 0.	

3-10-8. [:SOURce]:SIMulation:ABNormal:TIME (Set) →  
→ (Query)

Description	Sets or queries the Time parameter of the abnormal step for the Simulation mode.	
Syntax	[:SOURce]:SIMulation:ABNormal:TIME {<NR2> MINimum MAXimum}	
Query Syntax	[:SOURce]:SIMulation:ABNormal:TIME?	
Parameter	<NR2> MINimum MAXimum	Time of the abnormal step in seconds 0.0001 999.9999
Return parameter	<NR2>	Returns the time of the abnormal step.
Example	:SIM:ABN:TIME 1 Sets the abnormal step time to 1 second.	

### 3-10-9. [:SOURce]:SIMulation:ABNormal:VOLTage

Set →  
→ Query

Description	Sets or queries the Vset parameter of the abnormal step for the Simulation mode.	
Syntax	[:SOURce]:SIMulation:ABNormal:VOLTage {<NR2> MINimum MAXimum}	
Query Syntax	[:SOURce]:SIMulation:ABNormal:VOLTage? [MINimum MAXimum]	
Parameter	<NR2>	Voltage of the abnormal step.
	MINimum	Minimum settable voltage
	MAXimum	Maximum settable voltage
Return parameter	<NR2>	Returns the voltage of the abnormal step. Fixed to 1 digit after the decimal point.
Example	:SIM:ABN:VOLT MAX Sets the abnormal step voltage to the maximum.	

### 3-10-10. [:SOURce]:SIMulation:CSTep

→ Query

Description	Returns the currently running step.	
Query Syntax	[:SOURce]:SIMulation:CSTep?	
Return parameter	<NR1>	Current step +0 = Initial step +1 = Normal1 step +2 = Transition1 step +3 = Abnormal step +4 = Transition2 step +5 = Normal2 step
Example	:SIM:CSTep? +1	

### 3-10-11. [:SOURce]:SIMulation:INITial:CODE

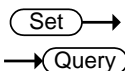

Description	Sets the external trigger output for the initial step parameter. This option is only applicable when in the Simulation mode.	
Syntax	[:SOURce]:SIMulation:INITial:CODE {<NR1> MINimum MAXimum}	
Query Syntax	[:SOURce]:SIMulation:INITial:CODE?	
Parameter	<NR1> MINimum MAXimum	0=LL, 1=LH, 2=HL, 3=HH 0 (LL) 3 (HH)
Return parameter	<NR1>	Returns the external trigger output for the initial step.
Example	SIM:INIT:CODE 1	

### 3-10-12. [:SOURce]:SIMulation:INITial:FREQUENCY

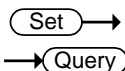

Description	Sets or queries the frequency of the initial step of the simulation mode.	
Syntax	[:SOURce]:SIMulation:INITial:FREQUENCY {<NR2> MINimum MAXimum}	
Query Syntax	[:SOURce]:SIMulation:INITial:FREQUENCY?	
Parameter	<NR2> MINimum MAXimum	Frequency of initial step Minimum frequency Maximum frequency
Return parameter	<NR2>	Returns the frequency of initial step. Fixed to 2 digits after the decimal point.
Example	:SIM:INIT:FREQ 60 Sets the frequency of the initial step to 60Hz.	

3-10-13. [:SOURce]:SIMulation:INITial:PHASe:  
START:ENABle

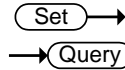

Description	Enables/Disables (Fixed/Free) the ON Phs parameter of the initial step for the Simulation mode.	
Syntax	[:SOURce]:SIMulation:INITial:PHASe:START:ENABle {<bool> OFF ON FREE FIXED}	
Query Syntax	[:SOURce]:SIMulation:INITial:PHASe:START:ENABle?	
Parameter	OFF   0   FREE	Disabled
	ON   1   FIXED	Enabled
Return parameter	+0	Disabled
	+1	Enabled
Example	:SIM:INIT:PHAS:STAR:ENAB 1 Enable the ON Phs.	

3-10-14. [:SOURce]:SIMulation:INITial:PHASe:  
START[:IMMediate]

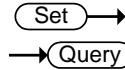

Description	Sets or queries the ON Phs parameter of the initial step for the Simulation mode.	
Syntax	[:SOURce]:SIMulation:INITial:PHASe:START[:IMMediate] {<NR2> MINimum MAXimum}	
Query Syntax	[:SOURce]:SIMulation:INITial:PHASe:START[:IMMediate]?	
Parameter	<NR2>	ON Phs (start phase)
	MINimum	0.0
	MAXimum	359.9
Return parameter	<NR2>	Returns the ON Phs (start phase). Fixed to 1 digit after the decimal point.
Example	:SIM:INIT:PHAS:STAR 0 Sets ON Phs to 0.	



3-10-15. [:SOURce]:SIMulation:INITial:PHASe:  
STOP:ENABLE

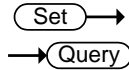

Description	Enables/Disables (Fixed/Free) the OFF Phs parameter of the initial step for the Simulation mode.	
Syntax	[:SOURce]:SIMulation:INITial:PHASe:STOP:ENABLE {<bool> OFF ON FREE FIXED }	
Query Syntax	[:SOURce]:SIMulation:INITial:PHASe:STOP:ENABLE?	
Parameter	OFF   0   FREE ON   1   FIXED	Disabled Enabled
Return parameter	+0 +1	Disabled Enabled
Example	:SIM:INIT:PHAS:STOP:ENAB 1 Enable the OFF Phs.	

3-10-16. [:SOURce]:SIMulation:INITial:PHASe:  
STOP[:IMMEDIATE]

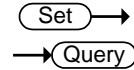

Description	Sets or queries the OFF Phs parameter of the initial step for the Simulation mode.	
Note:	Sets the off phase of the waveform after the output has been turned off.	
Syntax	[:SOURce]:SIMulation:INITial:PHASe:STOP[:IMMEDIATE] {<NR2> MINimum MAXimum}	
Query Syntax	[:SOURce]:SIMulation:INITial:PHASe:STOP[:IMMEDIATE]?	
Parameter	<NR2> MINimum MAXimum	OFF Phs (Stop phase) 0.0 359.9
Return parameter	<NR2>	Retuns the OFF Phs (Stop phase). Fixed to 1 digit after the decimal point.
Example	:SIM:INIT:PHAS:STOP 0 Sets OFF Phs to 0.	

3-10-17. [:SOURce]:SIMulation:INITial:VOLTage

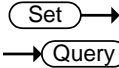

Description	Sets or queries the Vset parameter of the initial step for the Simulation mode.	
Syntax	[:SOURce]:SIMulation:INITial:VOLTage {<NR2> MINimum MAXimum}	
Query Syntax	[:SOURce]:SIMulation:INITial:VOLTage?	
Parameter	<NR2> MINimum MAXimum	Voltage of the initial step. Minimum settable voltage Maximum settable voltage
Return parameter	<NR2>	Returns the Voltage of the initial step. Fixed to 1 digit after the decimal point.
Example	:SIM:INIT:VOLT MAX Sets the initial step voltage to the maximum.	

3-10-18. [:SOURce]:SIMulation:NORMal<1|2>:CODE

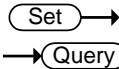

Description	Sets the external trigger output for the normal 1 or normal 2 step parameter. This option is only applicable when in the Simulation mode.	
Syntax	[:SOURce]:SIMulation:NORMal<1 2>:CODE {<NR1> MINimum MAXimum}	
Query Syntax	[:SOURce]:SIMulation:NORMal<1 2>:CODE?	
Parameter	<NR1> MINimum MAXimum	0=LL, 1=LH, 2=HL, 3=HH 0 (LL) 3 (HH)
Return parameter	<NR1>	Returns the external trigger output for the normal 1 or normal 2 step.
Example	SIM:NORM1:CODE 1	

3-10-19. [:SOURce]:SIMulation:NORMal 1  
:FREQUENCY

Set →  
→ Query

Description	Sets or queries the frequency of the normal1 step of the simulation mode.	
Syntax	[:SOURce]:SIMulation:NORMal 1:FREQUENCY {<NR2> MINimum MAXimum}	
Query Syntax	[:SOURce]:SIMulation:NORMal 1:FREQUENCY?	
Parameter	1 <NR2> MINimum MAXimum	Normal 1 Frequency of abnormal step Minimum frequency Maximum frequency
Return parameter	<NR2>	Returns the frequency of abnormal step. Fixed to 2 digits after the decimal point.
Example	:SIM:NORM1:FREQ 60 Sets the frequency to 60Hz.	

3-10-20. [:SOURce]:SIMulation:NORMal<1|2>:  
PHASe:STARt:ENABLE

Set →  
→ Query

Description	Enables/Disables (Fixed/Free) the ON Phs parameter of the normal1 or normal2 step for the Simulation mode.	
Syntax	[:SOURce]:SIMulation:NORMal<1 2>:PHASe:STARt:ENABLE { <bool> OFF ON FREE FIXED}	
Query Syntax	[:SOURce]:SIMulation:NORMal<1 2>:PHASe:STARt:ENABLE?	
Parameter	<1 2> OFF   0   FREE ON   1   FIXED	Normal 1 or Normal 2 Disabled Enabled
Return parameter	+0 +1	Disabled Enabled
Example	:SIM:NORM1:PHAS:STAR:ENAB 1 Enable the ON Phs.	

3-10-21. [:SOURce]:SIMulation:NORMal<1|2>:  
PHASe:STARt[:IMMEDIATE]

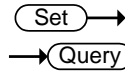

Description	Sets or queries the ON Phs parameter of the normal1 or normal2 step for the Simulation mode.	
Syntax	[:SOURce]:SIMulation:NORMal<1 2>:PHASe:STARt[:IMMEDIATE] {<NR2> MINimum MAXimum}	
Query Syntax	[:SOURce]:SIMulation:NORMal<1 2>:PHASe:STARt[:IMMEDIATE]?	
Parameter	<1 2>	Normal 1 or Normal 2
	<NR2>	ON Phs (start phase)
	MINimum	0.0
	MAXimum	359.9
Return parameter	<NR2>	Returns the ON Phs (start phase). Fixed to 1 digit after the decimal point.
Example	:SIM:NORM1:PHAS:STAR 0 Sets ON Phs to 0.	

3-10-22. [:SOURce]:SIMulation:NORMal<1|2>:  
PHASe:STOP:ENABLE

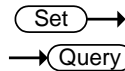

Description	Enables/Disables (Fixed/Free) the OFF Phs parameter of the normal1 or normal2 step for the Simulation mode.	
Syntax	[:SOURce]:SIMulation:NORMal<1 2>:PHASe:STOP:ENABLE {<bool> OFF ON FREE FIXED}	
Query Syntax	[:SOURce]:SIMulation:NORMal<1 2>:PHASe:STOP:ENABLE?	
Parameter	<1 2>	Normal 1 or Normal 2
	OFF   0   FREE	Disabled
	ON   1   FIXED	Enabled
Return parameter	+0	Disabled
	+1	Enabled
Example	:SIM:NORM1:PHAS:STOP:ENAB 1 Enable the OFF Phs.	

3-10-23. [:SOURce]:SIMulation:NORMal<1|2>:  
PHASe:STOP[:IMMEDIATE]

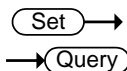

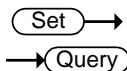

Description	Sets or queries the OFF Phs parameter of the normal1 or normal2 step for the Simulation mode.	
Note:	Sets the off phase of the waveform after the output has been turned off.	
Syntax	[:SOURce]:SIMulation:NORMal<1 2>:PHASe:STOP[:IMMEDIATE] {<NR2> MINimum MAXimum}	
Query Syntax	[:SOURce]:SIMulation:NORMal<1 2>:PHASe:STOP[:IMMEDIATE]?	
Parameter	<1 2> <NR2> MINimum MAXimum	Normal 1 or Normal 2 OFF Phs (Stop phase) 0.0 359.9
Return parameter	<NR2>	Returns the OFF Phs (Stop phase). Fixed to 1 digit after the decimal point.
Example	:SIM:NORM1:PHAS:STOP 0 Sets OFF Phs to 0.	

3-10-24. [:SOURce]:SIMulation:NORMal<1|2>:  
TIME



Description	Sets or queries the Time parameter of the normal1 or normal2 step for the Simulation mode.	
Syntax	[:SOURce]:SIMulation:NORMal<1 2>:TIME {<NR2> MINimum MAXimum}	
Query Syntax	[:SOURce]:SIMulation:NORMal<1 2>:TIME?	
Parameter	<1 2> <NR2> MINimum MAXimum	Normal 1 or Normal 2 Time of the step in seconds 0.0001 999.9999
Return parameter	<NR2>	Returns the time of the step.

Example :SIM:NORM1:TIME 1  
Sets the step time to 1 second.

3-10-25. [:SOURce]:SIMulation:NORMal1:VOLTage  

Description Sets or queries the Vset parameter of the normal1 step for the Simulation mode.

Syntax [:SOURce]:SIMulation:NORMal 1:VOLTage {<NR2>|MINimum|MAXimum}

Query Syntax [:SOURce]:SIMulation:NORMal 1:VOLTage?

Parameter	1 <NR2> MINimum MAXimum	Normal 1 Voltage of the abnormal step. Minimum settable voltage Maximum settable voltage
Return parameter	<NR2>	Returns the Voltage of the abnormal step. Fixed to 1 digit after the decimal point.

Example :SIM:NORM1:VOLT MAX  
Sets the normal1step voltage to the maximum.

3-10-26. [:SOURce]:SIMulation:REPeat:COUNT  

Description Sets or queries the repeat count for the Simulation mode.

Syntax [:SOURce]:SIMulation:REPeat:COUNT {<NR1>|MINimum|MAXimum}

Query Syntax [:SOURce]:SIMulation:REPeat:COUNT?

Parameter	<NR1> MINimum MAXimum	0 ~ 9999 (0 = infinite loop) 0 9999
Return parameter	<NR1>	+0 ~ +9999 (0 = infinite loop)

Example :SIM:REP:COUN 1  
Sets the repeat count to 1.

### 3-10-27. [:SOURce]:SIMulation:REPeat:ENABLE

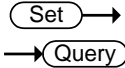

Description	Turns the repeat function on or off for the Simulation mode.	
Syntax	[:SOURce]:SIMulation:REPeat:ENABLE {<bool> OFF ON}	
Query Syntax	[:SOURce]:SIMulation:REPeat:ENABLE?	
Parameter	OFF   0 ON   1	Disabled Enabled
Return parameter	+0 +1	Disabled Enabled
Example	:SIM:REP:ENAB 1 Enables the repeat function.	

### 3-10-28. [:SOURce]:SIMulation:TRANSition<1|2>:TIME

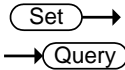

Description	Sets or queries the Time parameter of the transition step for the Simulation mode.	
Syntax	[:SOURce]:SIMulation:TRANSition<1 2>:TIME {<NR2> MINimum MAXimum}	
Query Syntax	[:SOURce]:SIMulation:TRANSition<1 2>:TIME?	
Parameter	<NR2> MINimum MAXimum	Time of the step in seconds 0 999.9999
Return parameter	<NR2>	Returns the time of the step.
Example	:SIM:TRAN1:TIME 1 Sets the step time to 1 second.	

### 3-10-29. [:SOURce]:SIMulation:TRANSition<1|2>:CODE

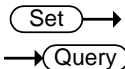

Description	Sets the external trigger output for the transition step parameter. This option is only applicable when in the Simulation mode.	
-------------	---	--

Syntax	[:SOURce]:SIMulation:TRANsition<1 2>:CODE {<NR1> MINimum MAXimum}	
Query Syntax	[:SOURce]:SIMulation:TRANsition<1 2>:CODE?	
Parameter	<NR1>	0=LL, 1=LH, 2=HL, 3=HH MINimum 0 (LL) MAXimum 3 (HH)
Return parameter	<NR1>	Returns the external trigger output for the transition step.
Example	SIM:TRAN1:CODE 1	

### 3-10-30. :TRIGger:SIMulation:SELEcted:EXECute

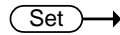

Description	Sets to execute actions for simulate mode	
Syntax	:TRIGger:SIMulation:SELEcted:EXECute {STOP START HOLD}	
Parameter	STOP START HOLD	Stops simulate execution Starts simulate execution Holds simulate execution
Example	TRIG:SIM:SEL:EXEC STAR Starts simulate execution.	



## 3-11. Input Subsystem Command

Set →

### 3-11-1. :INPut:GAIN

→ Query

Description	Sets or queries the input gain value. (Only AC+DC-EXT or AC-EXT or AC+DC-ADD or AC-ADD Active)	
Syntax	:INPut:GAIN {<NR2>(V) MINimum MAXimum}	
Query Syntax	:INPut:GAIN?	
Parameter/Return parameter	<NR2>	Input gain value
	MINimum	Minimum input gain value
	MAXimum	Maximum input gain value
Example	:INP:GAIN? +150.0 Returns the input gain value as 150.0.	

Set →

### 3-11-2. :INPut:SYNC:SOURce

→ Query

Description	Sets or queries state of sync source. (Only AC+DC-sync or AC-sync Active)	
Syntax	:INPut:SYNC:SOURce {<NR1> LINE EXT}	
Query Syntax	:INPut:SYNC:SOURce?	
Parameter/Return parameter	<NR1>	LINE (0) EXT (1)
	LINE	LINE sync source
	EXT	EXT sync source
Example	:INP:SYNC:SOUR? EXT Returns the state of sync source as EXT.	

## 3-12. Display Command

### 3-12-1.:DISPlay[:WINDow]:DESIgn:MODE

Set →

Description	Sets two display mode.	
Syntax	:DISPlay[:WINDow]:DESIgn:MODE{NORMAl SIMPle}	
Parameter	MORMAl	Configure setup and Measurement.
	SIMPle	All measurement times.
Example	:DISP:DES:MODE NORM Sets standard normal display.	

### 3-12-2.:DISPlay[:WINDow]:MEASure:SOURce <1|2|3>

Set →

Description	Sets standard normal display to measurement items 1 – 3.	
Syntax	:DISPlay[:WINDow]:MEASure:SOURce<1 3> { VRMS VAVG VMAX VMIN IRMS IAVG IMAX IMIN  IPKH RPOWer SPOWer QPOWer FREQuency PF ACtor CFACtor THDV THDI}	
Parameter	Item 1	VRMS , VAVG , VMAX , VMIN , RPOWer , SPOWer <sup>*1</sup> , QPOWer <sup>*1</sup> , THDV <sup>*2</sup>
	Item 2	IRMS , IAVG , IMAX , IMIN , IPKH , PFACTOR <sup>*1</sup> , CFACTOR <sup>*1</sup> , THDI <sup>*2</sup>
	Item 3	RPOWer , SPOWer <sup>*1</sup> , QPOWer <sup>*1</sup> , IPKH , PFACTOR <sup>*1</sup> , CFACTOR <sup>*1</sup> , FREQuency <sup>*3</sup>
	Note	*1: Not available for DC-INT *2: Available for AC-INT only *3: Available for AC+DC-Sync & AC- Sync only
Example	:DISP:MEAS:SOURC1 VRMS Sets measurement source 1 VRMS display.	

## 4. Status Register Overview

---

To program the ASR power supply effectively, the Status registers need to be understood. This chapter explains in detail how the Status registers are used and how to configure them.

### 4-1. Introduction to the Status Registers

---

#### Overview

The status registers are used to determine the status of the power supply. The status registers maintain the status of the protection conditions, operation conditions and instrument errors.

The ASR Series have a number of register groups:

- Questionable Status Register Group
- Standard Event Status Register Group
- Operation Status Register Group
- Warning Status Register Group
- System Lock Status Register Group
- Status Byte Register
- Service Request Enable Register
- Service Request Generation
- Error Queue
- Output Buffer

The diagram below shows the structure of the Status registers.

## 4-2. The Status Registers

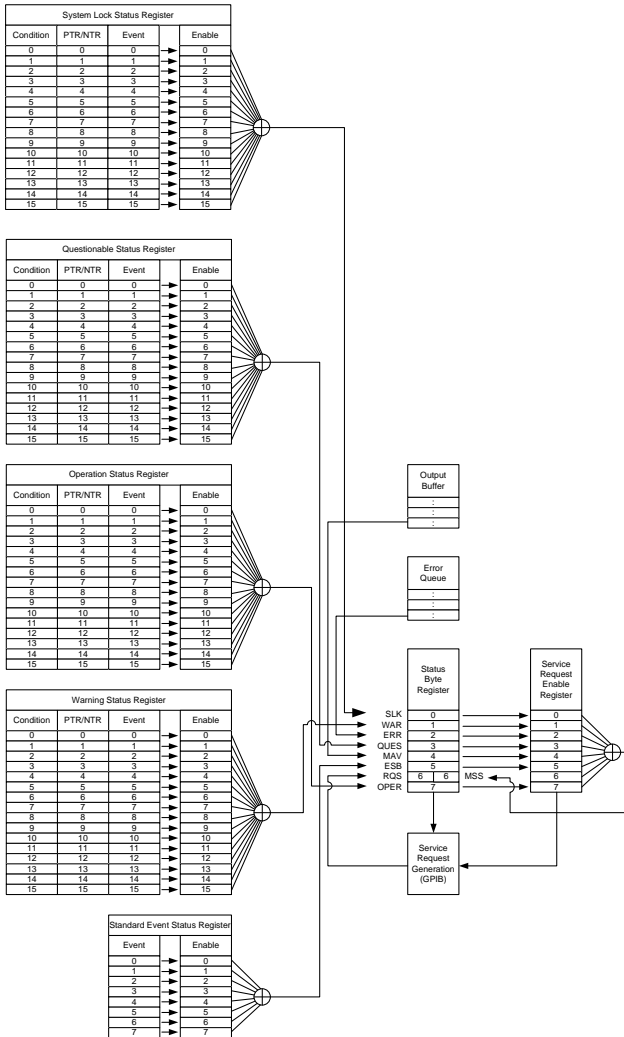

## 4-3.Questionable Status Register Group

### Overview

The Questionable Status Register Group indicates if any protection modes or limits have been tripped.

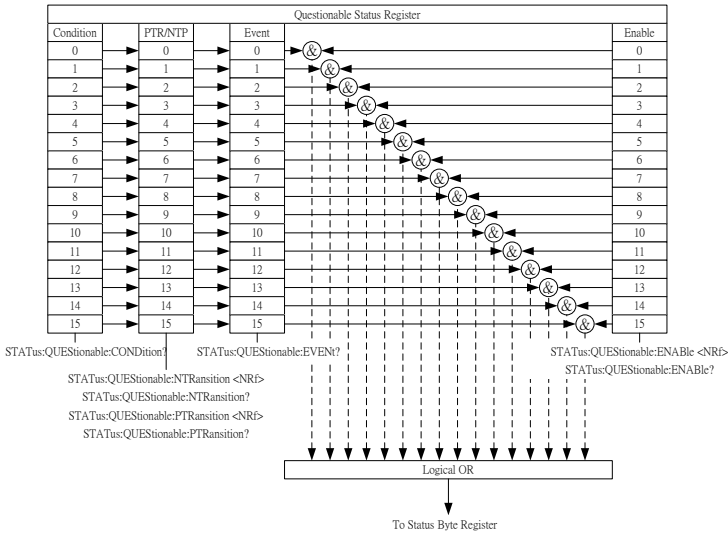

### Bit Summary

Event	Bit #	Bit Weight
Output Overvoltage	0	1
Over internal maximum voltage (110% of rating voltage).		
Over Irms Current	1	2
Output current RMS value is excessive		
Overheat	4	16
Internal power stage over heat.		
Output Short	5	32
Call attention to output terminal short status		

	Over I <sub>peak+</sub> Current or Over I <sub>peak-</sub> Current Positive/Negative output current peak value is excessive.	6	64
	Fan Failure Fan failure. Contact service center.	7	128
	Calibration Data Error The calibration data is abnormal or out of allowance range.	8	256
	Output Over-Power Over internal power stage maximum power (110% of rating power)	9	512
	IPK Limit The peak current limiter is activated.	10	1024
	Remote Sensing Voltage Out of Range The Sensing voltage limiter is activated.	11	2048
	IRMS Limit The RMS current limiter is activated.	12	4096
	Always 0	15	32768
Condition Register	The Questionable Status Condition Register indicates the status of the power supply. If a bit is set in the Condition register, it indicates that the event is true. Reading the condition register does not change the state of the condition register.		

---

**PTR/NTR Filters** The PTR/NTR (Positive/Negative transition) register determines the type of transition conditions that will set the corresponding bit in the Event Registers. Use the Positive transition filter to view events that change from false to positive, and use the negative transition filter to view events that change from positive to negative.

---

Positive Transition            0→1

Negative Transition           1→0

---

**Event Register** The PTR/NTR Register will dictate the type of transition conditions will set the corresponding bits in the Event Register. If the Event Register is read, it will be cleared to 0.

---

**Enable Register** The Enable register determines which Events in the Event Register will be used to set the QUES bit in the Status Byte Register.

## 4-4.Operation Status Register Group

### Overview

The Operation Status Register Group indicates the operating status of the power supply.

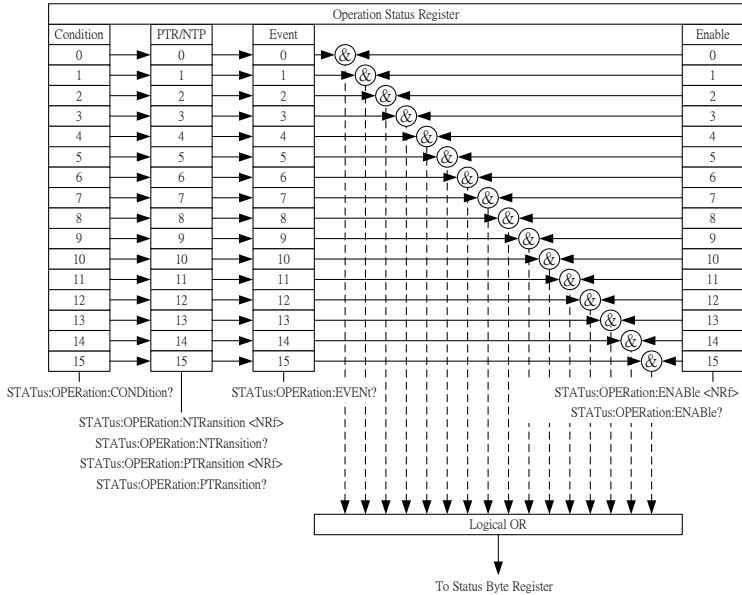

### Bit Summary

Event	Bit #	Bit Weight
Busy Status	1	2
LOCK status (SYNC) status	8	256
Hold Status(Sequence)	12	4096
Run Status(Sequence)	14	16384
Always 0	15	32768

### Condition Register

The Operation Status Condition Register indicates the operating status of the power supply. If a bit is set in the Condition register, it indicates that the event is true. Reading the condition register does not change the state of the condition register.



---

**PTR/NTR Filters** The PTR/NTR (Positive/Negative transition) register determines the type of transition conditions that will set the corresponding bit in the Event Registers. Use the Positive transition filter to view events that change from false to positive, and use the negative transition filter to view events that change from positive to negative.

---

Positive Transition            0→1

Negative Transition           1→0

---

**Event Register** The PTR/NTR Register will dictate the type of transition conditions will set the corresponding bits in the Event Register. If the Event Register is read, it will be cleared to 0.

---

**Enable Register** The Enable register determines which registered Events in the Event Register will be used to set the OPER bit in the Status Byte Register.

## 4-5.Warning Status Register Group

### Overview

The Warning Status Register Group is a secondary protection status register for the supply output.

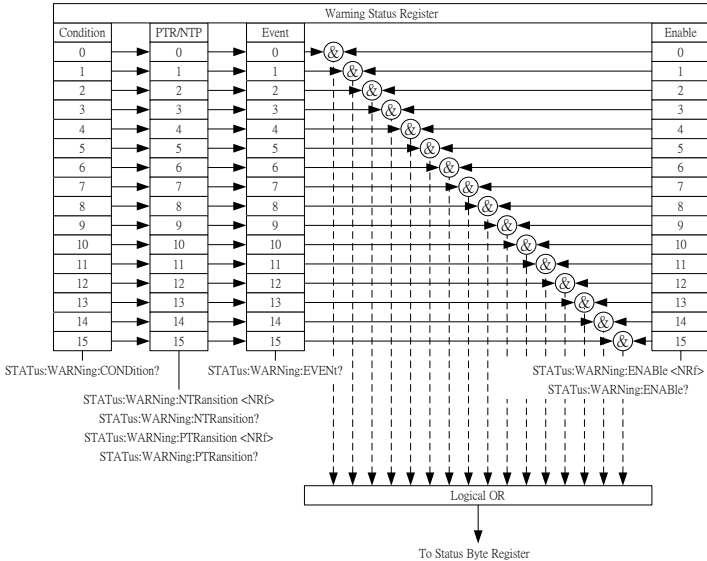

### Bit Summary

Event	Bit #	Bit Weight
Output Overvoltage	0	1
Over internal maximum voltage (110% of rating voltage).		
Over Irms Current	1	2
Output current RMS value is excessive		
Over Ipeak+ Current or Over Ipeak- Current	3	8
Positive/Negative output current peak value is excessive.		

Overheat	6	64
Internal power stage over heat.		
External Sync Frequency Error	7	128
The external synchronization signal input frequency is out of the allowance range. (40Hz ~ 999.9Hz)		
Sensing Voltage Error	9	512
Remote sense connection wire is abnormal or over maximum compensation voltage.		
Over Irms Current	10	1024
Output current RMS value is excessive		
Over Ipeak+ Current or Over Ipeak- Current	11	2048
Positive/Negative output current peak value is excessive.		
Output Over-Power	12	4096
Over internal power stage maximum power (110% of rating power)		
IRMS Limit	13	8192
The RMS current limiter is activated.		
IPK Limit	14	16384
The peak current limiter is activated.		
Always 0	15	32768

Condition Register	The System Lock Status Condition Register indicates the system lock status of the power supply. If a bit is set in the Condition register, it indicates that the event is true. Reading the condition register does not change the state of the condition register.				
PTR/NTR Filters	The PTR/NTR (Positive/Negative transition) register determines the type of transition conditions that will set the corresponding bit in the Event Registers. Use the Positive transition filter to view events that change from false to positive, and use the negative transition filter to view events that change from positive to negative. <table border="1" data-bbox="367 564 748 647"> <tr> <td>Positive Transition</td> <td>0→1</td> </tr> <tr> <td>Negative Transition</td> <td>1→0</td> </tr> </table>	Positive Transition	0→1	Negative Transition	1→0
Positive Transition	0→1				
Negative Transition	1→0				
Event Register	The PTR/NTR Register will dictate the type of transition conditions will set the corresponding bits in the Event Register. If the Event Register is read, it will be cleared to 0.				
Enable Register	The Enable register determines which registered Events in the Event Register will be used to set the SLK bit in the Status Byte Register.				

## 4-6. System Lock Status Register Group

### Overview

The System Lock Status Register Group indicates if system lock protection modes have been tripped.

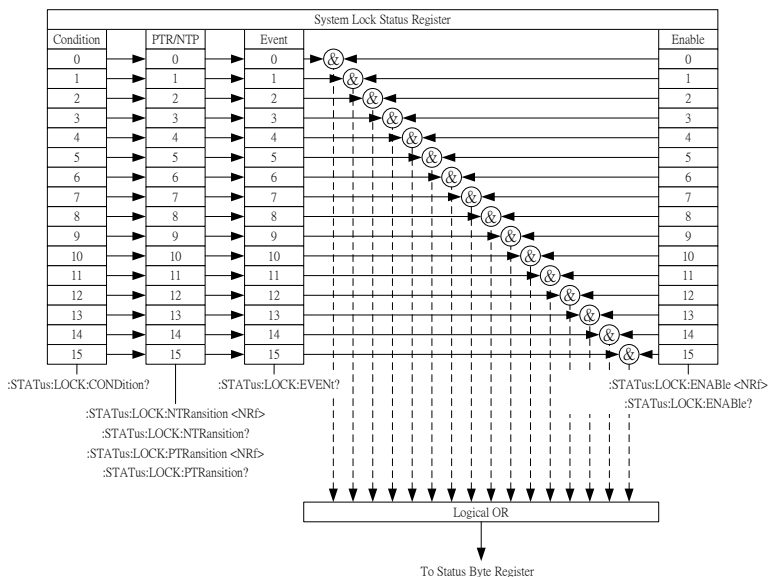

### Bit Summary

Event	Bit #	Bit Weight
Power Input Anomaly	0	1
The power input voltage is insufficient or turning off main power switch. Check input power before rebooting the unit.		
Fan Failure	7	128
Fan failure. Contact service center.		
Startup Anomaly	8	256
Abnormal startup procedure.		

Condition Register	The System Lock Status Condition Register indicates the system lock status of the power supply. If a bit is set in the Condition register, it indicates that the event is true. Reading the condition register does not change the state of the condition register.	
PTR/NTR Filters	The PTR/NTR (Positive/Negative transition) register determines the type of transition conditions that will set the corresponding bit in the Event Registers. Use the Positive transition filter to view events that change from false to positive, and use the negative transition filter to view events that change from positive to negative.	
	Positive Transition	0→1
	Negative Transition	1→0
Event Register	The PTR/NTR Register will dictate the type of transition conditions will set the corresponding bits in the Event Register. If the Event Register is read, it will be cleared to 0.	
Enable Register	The Enable register determines which registered Events in the Event Register will be used to set the SLK bit in the Status Byte Register.	

## 4-7. Standard Event Status Register Group

### Overview

The Standard Event Status Register Group indicates if any errors have occurred. The bits of the Event register are set by the error event queue.

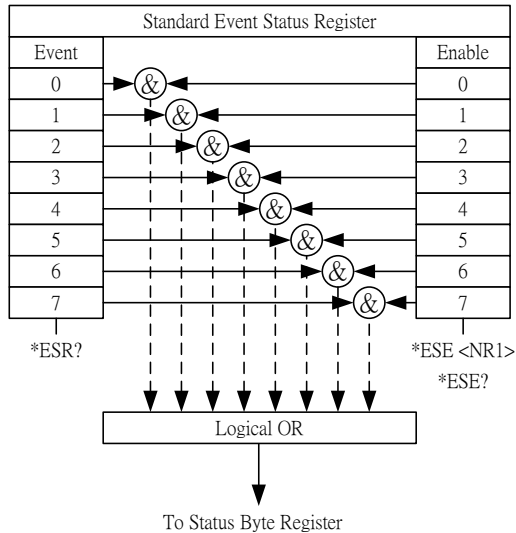

### Bit Summary

Event	Bit #	Bit Weight
OPC (Operation complete)	0	1
The OCP bit is set when all selected pending operations are complete. This bit is set in response to the *OPC command.		
RQC (Request control)	1	2
QUE (Query Error)	2	4
The Query Error bit is set in response to an error reading the Output Queue. This can be caused by trying to read the Output Queue when there is no data present.		

	DDE (Device Dependent Error)	3	8
	Device specific error.		
	EXE (Execution Error)	4	16
	The EXE bit indicates an execution error due to one of the following: illegal command parameter, parameter out of range, invalid parameter, the command didn't execute due to an overriding operation condition.		
	CME (Command Error)	5	32
	The CME bit is set when a syntax error has occurred. The CME bit can also be set when a <GET> command is received within a program message.		
	URQ (User Request)	6	64
	PON (Power On)	7	128
	Indicates the power is turned on.		
Event Register	Any bits set in the event register indicate that an error has occurred. Reading the Event register will reset the register to 0.		
Enable Register	The Enable register determines which Events in the Event Register will be used to set the ESB bit in the Status Byte Register.		



## 4-8. Status Byte Register & Service Request Enable Register

### Overview

The Status Byte register consolidates the status events of all the status registers. The Status Byte register can be read with the \*STB? query and can be cleared with the \*CLS command.

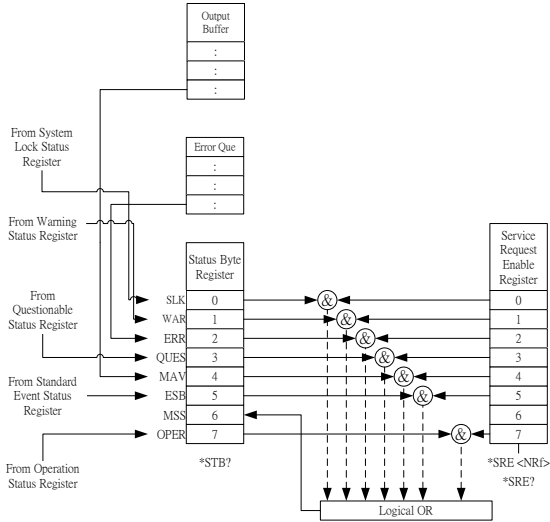

### Bit Summary

Event	Bit #	Bit Weight
SLK(System Lock Status Register Summary)	0	1
WAR (Warning Status Register)	1	2
ERR (Error Queue not empty)	2	4
QUES (Questionable Status Register)	3	8
MAV (Message Available)	4	16
ESB(Standard Event Status Register Summary)	5	32
RQS / MSS(Reuest Service / Master Summary Status)	6	64

	OPER (Operation Status Register)	7	128
Status Byte Register	Any bits set in the Status byte register acts as a summary register for all the three other status registers and indicates if there is a service request, an error in the Error Queue or data in the Output Queue. Reading the Status Byte register will reset the register to 0.		
Service Request Enable Register	The Service Request Enable Register controls which bits in the Status Byte Register are able to generate service requests.		

## 5. Error List

---

### 5-1.Command Errors

---

Overview	<p>An &lt;error/event number&gt; in the range [ -199 , -100 ] indicates that an IEEE 488.2 syntax error has been detected by the instrument's parser. The occurrence of any error in this class shall cause the command error bit (bit 5) in the event status register (IEEE 488.2, section 11.5.1) to be set. One of the following events has occurred:</p> <ul style="list-style-type: none"><li>• An IEEE 488.2 syntax error has been detected by the parser. That is, a controller-to-device message was received which is in violation of the IEEE 488.2 standard. Possible violations include a data element which violates the device listening formats or whose type is unacceptable to the device.</li><li>• An unrecognized header was received. Unrecognized headers include incorrect device-specific headers and incorrect or unimplemented IEEE 488.2 common commands.</li></ul> <p>Events that generate command errors shall not generate execution errors, device-specific errors, or query errors; see the other error definitions in this chapter.</p>
----------	--

Error Code	Description
-100 Command Error	This is the generic syntax error for devices that cannot detect more specific errors. This code indicates only that a Command Error as defined in IEEE 488.2,11.5.1.1.4 has occurred.
-102 Syntax error	An unrecognized command or data type was encountered; for example, a string was received when the device does not accept strings.

-103 Invalid separator	The parser was expecting a separator and encountered an illegal character; for example, the semicolon was omitted after a program message unit, MEAS:VOLT:DC?:MEASCURR:DC?
-104 Data type error	The parser recognized a data element different than one allowed; for example, numeric or string data was expected but block data was encountered.
-108 Parameter not allowed	More parameters were received than expected for the header; for example, the :SYSTem:KLOCK command only accepts one parameter, so receiving SYSTem:KLOCK 1,0 is not allowed.
-109 Missing parameter	Fewer parameters were received than required for the header; for example, the :SYSTem:KLOCK command requires one parameter, so receiving :SYSTem:KLOCK is not allowed.
-111 Header separator error	A character which is not a legal header separator was encountered while parsing the header; for example, no white space followed the header, thus *SRE2 is an error.
-112 Program mnemonic too long	The header contains more than twelve characters (see IEEE 488.2, 7.6.1.4.1).
-113 Undefined header	The header is syntactically correct, but it is undefined for this specific device; for example, *XYZ is not defined for any device.
-114 Header suffix out of range	The value of a numeric suffix attached to a program mnemonic, see Syntax and Style section 6.2.5.2, makes the header invalid.
-115 Unexpected number of parameters	The number of parameters received does not correspond to the number of parameters expected. This is typically due to an inconsistency with the number of instruments in the selected group.
-120 Numeric data error	This error, as well as errors -121 through -129, are generated when parsing a data element which appears to be numeric, including the nondecimal numeric types. This particular error message should be used if the device cannot detect a more specific error.

-121 Invalid character in number	An invalid character for the data type being parsed was encountered; for example, an alpha in a decimal numeric or a "9" in octal data.
-128 Numeric data not allowed	A legal numeric data element was received, but the device does not accept one in this position for the header.
-131 Invalid suffix	The suffix does not follow the syntax described in IEEE 488.2, 7.7.3.2, or the suffix is inappropriate for this device.
-141 Invalid character data	Either the character data element contains an invalid character or the particular element received is not valid for the header.
-148 Character data not allowed	A legal character data element was encountered where prohibited by the device.
-151 Invalid string data	A string data element was expected, but was invalid for some reason (see IEEE 488.2, 7.7.5.2); for example, an END message was received before the terminal quote character.
-158 String data not allowed	A string data element was encountered but was not allowed by the device at this point in parsing.
-160 Block data error	This error, as well as errors -161 through -169, are generated when parsing a block data element. This particular error message should be used if the device cannot detect a more specific error.
-161 Invalid block data	A block data element was expected, but was invalid for some reason (see IEEE 488.2, 7.7.6.2); for example, an END message was received before the length was satisfied.
-168 Block data not allowed	A legal block data element was encountered but was not allowed by the device at this point in parsing.
-178 Expression data not allowed	A legal expression data was encountered but was not allowed by the device at this point in parsing.

## 5-2. Execution Errors

---

Overview	An <error/event number> in the range [ -299 , -200 ] indicates that an error has been detected by the instrument's execution control block. The
----------	---

---

occurrence of any error in this class shall cause the execution error bit (bit 4) in the event status register (IEEE 488.2, section 11.5.1) to be set. One of the following events has occurred:

- A <PROGRAM DATA> element following a header was evaluated by the device as outside of its legal input range or is otherwise inconsistent with the device’s capabilities.
- A valid program message could not be properly executed due to some device condition.

Execution errors shall be reported by the device after rounding and expression evaluation operations have taken place. Rounding a numeric data element, for example, shall not be reported as an execution error. Events that generate execution errors shall not generate Command Errors, device-specific errors, or Query Errors; see the other error definitions in this section.

Error Code	Description
-200 Execution error	This is the generic syntax error for devices that cannot detect more specific errors. This code indicates only that an Execution Error as defined in IEEE 488.2, 11.5.1.1.5 has occurred.
-201 Invalid while in local	Indicates that a command is not executable while the device is in local due to a hard local control (see IEEE 488.2, 5.6.1.5); for example, a device with a rotary switch receives a message which would change the switches state, but the device is in local so the message cannot be executed.
-203 Command protected	Indicates that a legal password-protected program command or query could not be executed because the command was disabled.

-211 Trigger ignored	Indicates that a GET, *TRG, or triggering signal was received and recognized by the device but was ignored because of device timing considerations; for example, the device was not ready to respond. Note: a DT0 device always ignores GET and treats *TRG as a Command Error.
-213 Init ignored	Indicates that a request for a measurement initiation was ignored as another measurement was already in progress.
-220 Parameter error	Indicates that a program data element related error occurred. This error message should be used when the device cannot detect the more specific errors described for errors -221 through -229.
-221 Settings conflict	Indicates that a legal program data element was parsed but could not be executed due to the current device state (see IEEE 488.2, 6.4.5.3 and 11.5.1.1.5.).
-222 Data out of range	Indicates that a legal program data element was parsed but could not be executed because the interpreted value was outside the legal range as defined by the device (see IEEE 488.2, 11.5.1.1.5.).
-224 Illegal parameter value	Used where exact value, from a list of possibles, was expected.

## 5-3.Device Specific Errors

---

### Overview

An <error/event number> in the range [ -399 , -300 ] or [ 1 , 32767 ] indicates that the instrument has detected an error which is not a command error, a query error, or an execution error; some device operations did not properly complete, possibly due to an abnormal hardware or firmware condition. These codes are also used for self-test response errors. The occurrence of any error in this class should cause the device-specific error bit (bit 3) in the event status register (IEEE 488.2, section 11.5.1) to be set. The meaning of positive error codes is device-dependent and may be enumerated or bit mapped; the <error message>string for positive error codes is not defined by SCPI and available to the device designer.

Note that the string is not optional; if the designer does not wish to implement a string for a particular error, the null string should be sent (for example, 42,""). The occurrence of any error in this class should cause the device-specific error bit (bit 3) in the event status register (IEEE 488.2, section 11.5.1) to be set. Events that generate device-specific errors shall not generate command errors, execution errors, or query errors; see the other error definitions in this section.

Error Code	Description
-310 System error	Indicates that some error, termed "system error" by the device, has occurred. This code is device-dependent.
-320 Storage fault	Indicates that the firmware detected a fault when using data storage. This error is not an indication of physical damage or failure of any mass storage element.



## 5-4.Query Errors

---

### Overview

An <error/event number> in the range [ -499 , -400 ] indicates that the output queue control of the instrument has detected a problem with the message exchange protocol described in IEEE 488.2, chapter 6. The occurrence of any error in this class shall cause the query error bit (bit 2) in the event status register (IEEE 488.2, section 11.5.1) to be set. These errors correspond to message exchange protocol errors described in IEEE 488.2, section 6.5. One of the following is true:

- An attempt is being made to read data from the output queue when no output is either present or pending;
- Data in the output queue has been lost.

Events that generate query errors shall not generate command errors, execution errors, or device-specific errors; see the other error definitions in this section.

Error Code	Description
-400 Query error	This is the generic query error for devices that cannot detect more specific errors. This code indicates only that a Query Error as defined in IEEE 488.2, 11.5.1.1.7 and 6.3 has occurred.

## 6. APPENDIX

### 6-1. Factory Default Settings

The following default settings are the factory configuration settings for the ASR series. For details on how to return to the factory default settings, please see the user manual.

AC+DC-INT Mode	ASR501-351(G)	ASR102-351(G)
Range		100V
Wave Shape		SIN
ACV		0.0 Vrms
DCV		+0.0 Vdc
FREQ		50.00 Hz
IRMS	5.25 A	10.50 A
V Limit		+/- 250.0 Vpp
F Limit Lo		1.0 Hz
F Limit Hi		999.9 Hz
IPK Limit	+/- 21.00 A	+/- 42.00 A
ON Phs		0.0°
OFF Phs		0.0°
AC-INT Mode	ASR501-351(G)	ASR102-351(G)
Range		100V
Wave Shape		SIN
ACV		0.0 Vrms
FREQ		50.00 Hz
IRMS	5.25 A	10.50 A
V Limit		175.0 Vrms
F Limit Lo		40.0 Hz
F Limit Hi		999.9 Hz
IPK Limit	+/- 21.00 A	+/- 42.00 A
ON Phs		0.0°
OFF Phs		0.0°
DC-INT Mode	ASR501-351(G)	ASR102-351(G)
Range		100V
DCV		0.0 Vdc
I	5.25 A	10.50 A
V Limit		+/- 250.0 Vpp
IPK Limit	+/- 21.00 A	+/- 42.00 A

AC+DC-EXT Mode	ASR501-351(G)	ASR102-351(G)
Range		100V
GAIN		100.0
IRMS	5.25 A	10.50 A
IPK Limit	+/- 21.00 A	+/- 42.00 A
AC-EXT Mode	ASR501-351(G)	ASR102-351(G)
Range		100V
GAIN		100.0
IRMS	5.25 A	10.50 A
IPK Limit	+/- 21.00 A	+/- 42.00 A
AC+DC-ADD Mode	ASR501-351(G)	ASR102-351(G)
Range		100V
Wave Shape		SIN
ACV		0.0 Vrms
DCV		+0.0 Vdc
GAIN		100.0
FREQ		50.00 Hz
IRMS	5.25 A	10.50 A
V Limit		+/- 250.0 Vpp
F Limit Lo		1.0 Hz
F Limit Hi		999.9 Hz
IPK Limit	+/- 21.00 A	+/- 42.00 A
ON Phs		0.0°
OFF Phs		0.0°
AC-ADD Mode	ASR501-351(G)	ASR102-351(G)
Range		100V
Wave Shape		SIN
ACV		0.0 Vrms
GAIN		100.0
FREQ		50.00 Hz
IRMS	5.25 A	10.50 A
V Limit		175.0 Vrms
F Limit Lo		40.0 Hz
F Limit Hi		999.9 Hz
IPK Limit	+/- 21.00 A	+/- 42.00 A
ON Phs		0.0°
OFF Phs		0.0°
AC+DC-SYNC Mode	ASR501-351(G)	ASR102-351(G)
Range		100V
Wave Shape		SIN

ACV		0.0 Vrms	
DCV		+0.0 Vdc	
SIG		LINE	
IRMS	5.25 A		10.50 A
V Limit		+/- 250.0 Vpp	
F Limit		999.9 Hz	
IPK Limit	+/- 21.00 A		+/- 42.00 A
ON Phs		0.0°	
OFF Phs		0.0°	
<b>AC-SYNC Mode</b>	<b>ASR501-351(G)</b>	<b>ASR102-351(G)</b>	
Range		100V	
Wave Shape		SIN	
ACV		0.0 Vrms	
SIG		LINE	
IRMS	5.25 A		10.50 A
V Limit		175.0 Vrms	
F Limit		999.9 Hz	
IPK Limit	+/- 21.00 A		+/- 42.00 A
ON Phs		0.0°	
OFF Phs		0.0°	
<b>Menu</b>	<b>ASR</b>		
T ipeak, hold(msec)		1 ms	
Ipkh CLR		EXEC	
Power ON		OFF	
Buzzer		ON	
Remote Sense		OFF	
Slew Rate Mode		Slope	
Output Relay		Enable	
THD Format		IEC	
External Control		OFF	
V Unit (TRI, ARB)		rms	
Data Average Count		1	
Data Update Rate		Fast	
TrgOut Source		None	
<b>LAN</b>	<b>ASR</b>		
DHCP		ON	
<b>USB Device</b>	<b>ASR</b>		
Speed		Full	
<b>LCD Configuration</b>	<b>ASR</b>		
LCD Contrast		50%	

LCD Brightness	50%
LCD Saturation	50%

<b>Sequence Mode</b>	<b>ASR</b>
Step	0
Time	0.1000 s
ACV	0.0, CT
DCV	0.0, CT
Fset	50.0, CT
Wave	SIN
Jump To	OFF
Jump Cnt	1
Branch 1	OFF
Branch 2	OFF
Term	CONTI
Sync Code	LL
ON Phs	Free
OFF Phs	Free

<b>Simulation Mode</b>	<b>ASR</b>
Step	Initial
Repeat	OFF
Time	0.1000 s
ACV	0.0
Fset	50.00
ON Phs	Free
OFF Phs	Free
Wave	SIN
Code	LL

<b>RS232C</b>	<b>G Type</b>
Baudrate	9600
Databits	8bits
Parity	None
Stopbits	1bit

<b>GPIB</b>	<b>G Type</b>
Address	10

**ARB 1~16 Waveform Pattern**

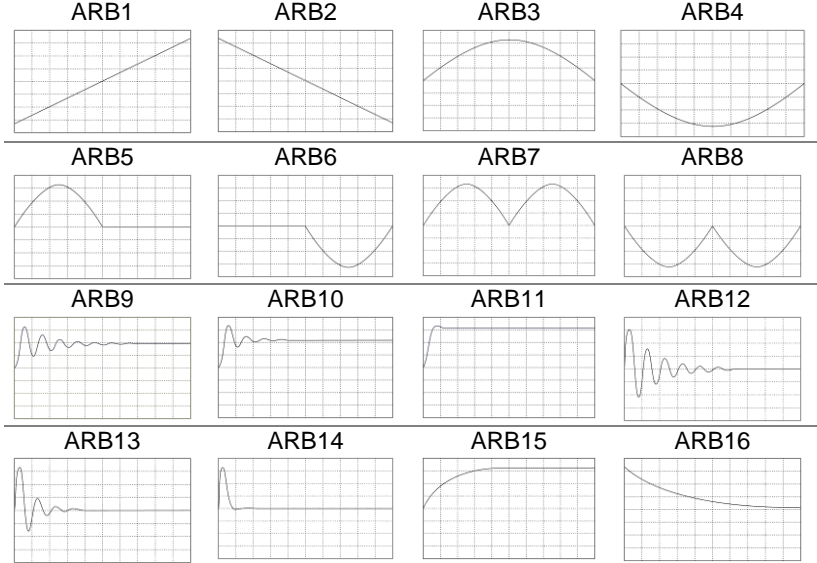



## **TEXIO TECHNOLOGY CORPORATION**

Towa Fudosan Shin Yokohama Bldg.

2-18-13, Shin Yokohama, Kohoku-ku, Yokohama, Kanagawa, 222-0033 Japan

<https://www.texio.co.jp/>

---